

Air Force Institute of Technology

AFIT Scholar

---

Theses and Dissertations

Student Graduate Works

---

3-2006

## A Real-time Wireless Sensor Media Access Control (MAC) Protocol

Barry W. Park

Follow this and additional works at: <https://scholar.afit.edu/etd>



Part of the [Information Security Commons](#)

---

### Recommended Citation

Park, Barry W., "A Real-time Wireless Sensor Media Access Control (MAC) Protocol" (2006). *Theses and Dissertations*. 3473.

<https://scholar.afit.edu/etd/3473>

This Thesis is brought to you for free and open access by the Student Graduate Works at AFIT Scholar. It has been accepted for inclusion in Theses and Dissertations by an authorized administrator of AFIT Scholar. For more information, please contact [richard.mansfield@afit.edu](mailto:richard.mansfield@afit.edu).



**A Real-time Wireless Sensor Media Access Control (MAC) Protocol**

THESIS

Barry W. Park, TSgt, USAF

AFIT/GIA/ENG/06-08

**DEPARTMENT OF THE AIR FORCE  
AIR UNIVERSITY**

***AIR FORCE INSTITUTE OF TECHNOLOGY***

---

---

**Wright-Patterson Air Force Base, Ohio**

APPROVED FOR PUBLIC RELEASE; DISTRIBUTION UNLIMITED

The views expressed in this thesis are those of the author and do not reflect the official policy or position of the United States Air Force, Department of Defense, or the U.S. Government.

AFIT/GIA/ENG/06-08

**A Real-time Wireless Sensor Media Access Control (MAC) Protocol**

THESIS

Presented to the Faculty

Department of Electrical and Computer Engineering

Graduate School of Engineering and Management

Air Force Institute of Technology

Air University

Air Education and Training Command

In Partial Fulfillment of the Requirements for the

Degree of Master of Science

Barry W. Park, BS

TSgt, USAF

March 2006

APPROVED FOR PUBLIC RELEASE; DISTRIBUTION UNLIMITED

## A Real-time Wireless Sensor Media Access Control (MAC) Protocol

Barry W. Park, BS

TSgt, USAF

Approved:

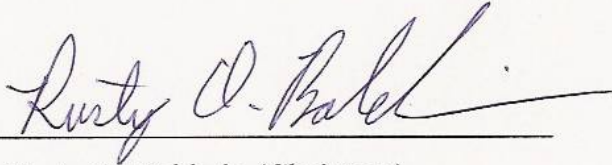

Dr. Rusty O. Baldwin (Chairman)

3 Mar 06

Date

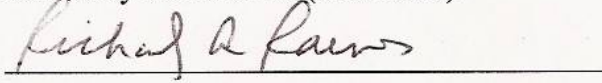

Dr. Richard A. Raines (Member)

3 Mar 06

Date

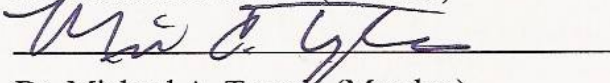

Dr. Michael A. Temple (Member)

3 Mar 06

Date

## Abstract

Wireless sensor networks are rapidly becoming a platform for applications such as battlefield monitoring, intelligence gathering, environmental monitoring, and emergency response. Inherent in these applications is a priority and urgency of the information or messages. This means the messages must be delivered in a timely manner for them to be useful. This research assigns a message priority level and provides high priority messages quicker access to the channel.

Using MICA2 sensors and a modified Media Access Control (MAC) layer, real-time message End-to-End (ETE) delay was reduced by 50 percent. Coupled with this decrease in delay, these same real-time messages also had a significantly higher on-time delivery rate compared to an unmodified system. At the highest loading levels, high priority messages experienced a 45 percent higher on-time delivery rate than the baseline system. These performance improvements were obtained without any impact on throughput for other message types and without the added overhead of channel reservation or system synchronization required by other protocols.

## Acknowledgments

I would like to express my sincere appreciation to my wife and family for their support during our visit to AFIT. I would also like to express my appreciation to my father, not a single phone call went unanswered. Lastly, I would like to thank my thesis advisor, Dr. Rusty Baldwin, whose structure and discipline provided me the opportunity for success while at AFIT.

Barry W. Park

## Table of Contents

	Page
Abstract.....	iv
Acknowledgments .....	v
Table of Contents.....	vi
List of Figures.....	viii
List of Tables .....	ix
List of Tables .....	ix
Introduction.....	1
1.1 Background.....	1
1.2 Goals .....	2
1.3 Document Overview .....	2
2. Background.....	4
2.1 Introduction.....	4
2.2 The OSI Model .....	4
2.2.1 Physical layer .....	6
2.2.2 Data Link layer .....	6
2.2.3 Network layer.....	7
2.2.4 Transport layer.....	7
2.2.5 Session layer .....	7
2.2.6 Presentation layer.....	8
2.2.7 Application layer.....	8
2.3 Media Access Control (MAC) Protocols.....	8
2.3.1 Time Division Multiple Access (TDMA).....	9
2.3.2 Frequency Division Multiple Access (FDMA).....	10
2.3.3 Code Division Multiple Access (CDMA).....	12
2.3.4 Carrier Sense Multiple Access (CSMA).....	13
2.3.5 Collision Detection .....	13
2.3.6 Collision Avoidance.....	14
2.4 Wireless (802.11).....	15
2.5 Wireless Issues.....	17
2.5.1 Collision Detection .....	18
2.5.2 Hidden Nodes.....	18
2.6 Current Real-time and wireless research .....	19
2.6.1 Reservation based protocols .....	20
2.6.2 Contention based protocols.....	24
2.6.3 Strict Delivery Bound .....	28
2.7 Summary .....	29
3. Methodology.....	31
3.1 Introduction.....	31
3.2 Problem Definition.....	31
3.2.1 Goals and Hypothesis .....	33
3.2.2 Approach.....	33
3.3 System Boundaries.....	34
3.4 System Services .....	35
3.5 Workload.....	36



3.6	Performance Metrics.....	36
3.7	Parameters.....	37
3.8	Factors.....	38
3.9	Evaluation Technique.....	39
3.10	Equipment Configuration.....	39
3.10.1	Hardware.....	39
3.10.2	Software.....	40
3.11	Experimental Design.....	41
3.12	Summary.....	42
4.	Data and Analysis.....	43
4.1	Introduction.....	43
4.2	System Validation.....	43
4.2.1	End-to-End (ETE) Delay.....	44
4.2.2	Throughput.....	46
4.2.3	Summary.....	47
4.3	Experimental Analysis.....	48
4.3.1	ETE Delay.....	49
4.3.2	On-Time Delivery.....	60
4.3.3	Throughput.....	67
4.4	Summary.....	73
5.	Conclusions.....	74
5.1	Introduction.....	74
5.2	Conclusions.....	74
5.3	Future Research.....	75
	Appendix A. ETE Experiment Data Analysis Tables.....	76
	Appendix B. On-Time Delivery Experiment Data Analysis Tables.....	78
	Appendix C. Throughput Experiment Data Analysis Tables.....	79
	Bibliography.....	81

## List of Figures

	Page
Figure 1. OSI Network Model .....	5
Figure 2. OSI Communication [FoF06].....	5
Figure 3. TDMA [Mul06] .....	9
Figure 4. TDMA Idle Timeslots [Mul06] .....	10
Figure 5. FDMA [Mul06] .....	11
Figure 6. CMDA [Mul06].....	12
Figure 7. IEEE 802.11 DCF [80206] .....	16
Figure 8. IEEE 802.11 DCF with handshaking [80206].....	17
Figure 9. Hidden Nodes .....	19
Figure 10. AACA-CT Performance Improvement [LLF01].....	21
Figure 11. Priority MAC Performance Improvement [JLW04] .....	23
Figure 12. DHP Channel Access Performance Improvement [RPS00].....	25
Figure 13. Dynamic IEEE 802.11 Performance Results [CCG00].....	26
Figure 14. Fast Collision Resolution Performance Results [KFL03] .....	27
Figure 15. RT-MAC Performance [Bal99].....	29
Figure 16. System and Component Under Test .....	35
Figure 17. Experiment Configuration .....	40
Figure 18. OPNET ETE Delay Results (802.11).....	45
Figure 19. MICA2 ETE Delay Results .....	45
Figure 20. OPNET Throughput Results (802.11).....	46
Figure 21. MICA2 Throughput Results .....	47
Figure 22. ETE Delay using 2 High priority nodes and 250ms Deadline .....	51
Figure 23. ETE Delay using 2 High priority nodes and 500ms Deadline .....	51
Figure 24. ETE Delay using 2 High priority nodes and 250ms Deadline .....	52
Figure 25. ETE Delay using 2 High priority nodes and 500ms Deadline .....	52
Figure 26. ETE Delay using 6 High priority nodes and 250ms Deadline .....	53
Figure 27. ETE Delay using 6 High priority nodes and 500ms Deadline .....	54
Figure 28. ETE Delay using 6 High priority nodes and 250ms Deadline .....	55
Figure 29. ETE Delay using 6 High priority nodes and 500ms Deadline .....	55
Figure 30. ETE Delay ANOVA Validation.....	56
Figure 31. ETE Main Effects .....	58
Figure 32. On-Time Delivery using 2 High Priority Nodes and 250ms Deadline .....	61
Figure 33. On-Time Delivery using 2 High Priority Nodes and 500ms Deadline .....	61
Figure 34. On-Time Delivery using 6 High Priority Nodes and 250ms Deadline .....	62
Figure 35. On-Time Delivery using 6 High Priority Nodes and 500ms Deadline .....	63
Figure 36. On-Time Delivery ANOVA Validation .....	64
Figure 37. On-Time Delivery Main Effects.....	66
Figure 38. Throughput using 2 High Priority Nodes and 250ms Deadline .....	68
Figure 39. Throughput using 2 High Priority Nodes and 500ms Deadline .....	68
Figure 40. Throughput using 6 High Priority Nodes and 250ms Deadline .....	69
Figure 41. Throughput using 6 High Priority Nodes and 500ms Deadline .....	69
Figure 42. Throughput ANOVA Validation.....	70
Figure 43. Throughput Main Effects .....	72

## List of Tables

	Page
Table 1. ETE Delay ANOVA .....	57
Table 2. On-Time Delivery ANOVA .....	65
Table 3. Throughput ANOVA .....	71
Table 4. ETE 90% Confidence Intervals .....	76
Table 5. ETE Delay ANOVA .....	77
Table 6. On-Time Delivery 90% Confidence Intervals .....	78
Table 7. On-time Delivery ANOVA.....	78
Table 8. Throughput 90% Confidence Intervals.....	79
Table 9. Throughput ANOVA .....	80

# A Real-time Wireless Sensor Media Access Control (MAC) Protocol

## Introduction

### 1.1 Background

The emerging importance and reliance on information is leading to a surge in new applications with potential military use. One of the key technologies is the migration from wired to wireless networks. With this trend, wide varieties of applications are being implemented on wireless platforms, especially sensors of all kinds. These sensors are rapidly becoming embedded computing platforms with the ability to sense sound, light, vibration, heat and many other phenomenon, all at the scale of a package of chewing gum. Applications ranging from battlefield monitoring, environment monitoring, and emergency response are just a few examples of applications designed for these platforms. Each application transmits messages from one node to another to reach a destination where a decision based on the information is made.

The messages, or information transfers, may be urgent or have some real-time aspect to it. This means it must be delivered in a relatively short timeframe to be of use. Messages that are not delivered in a timely manner are either discarded or replaced with current data. While most networks are designed to deliver all messages, sensor networks periodically provide current readings from various inputs. In these types of networks considerable time and bandwidth is wasted by attempting to transmit all messages that are generated. By discarding out-of-date messages, better use of the network can be obtained.

Many current protocols require either a reservation based mechanism or synchronization of the nodes to deliver real-time messages on time. Both of these approaches create overhead in the network. Overhead in a reservation-based scheme comes in the form of additional messages to set up the reservation before the actual message is transmitted. Synchronization overhead comes in the form of additional messages to maintain sufficient synchronization of all nodes. If a simple modification to the MAC layer can improve the performance of real-time messages, this would have the benefit of the performance improvement of other real-time protocols without the additional overhead they require.

## **1.2 Goals**

The goal of this research is to improve the real-time performance of wireless sensor networks. To determine the impact that modifications to the MAC layer have on the performance of the network, three performance metrics are used: end-to-end delay, on-time delivery, and throughput. An 802.11 wireless protocol is used as the base protocol but the protocol is modified to include a message priority field at the application layer and the MAC layer is modified to give high priority messages quicker access to the channel over low priority messages.

## **1.3 Document Overview**

This chapter introduces wireless sensor networks with a focus on the MAC layer of the communications protocol. It also presents the goals of this research. Chapter 2 contains

background information on wired and wireless networking and current real-time protocol research. Chapter 3 provides the methodology and wireless apparatus used to conduct this research. Chapter 4 discusses the experimental process, validates the experimental data, and analyzes the results of the experiments. Finally, Chapter 5 presents the conclusions of this research.

## 2. Background

### 2.1 Introduction

Wireless networks share many similarities with conventional wired networks. The standards for wireless networks have generally followed those of wired networks. With the maturing standards for wireless networks providing the stability needed for reliable operation, wireless networks are quickly becoming the network of choice for many network implementations. The 802.11 protocol is the industry standard wireless protocol and enjoys widespread support. This chapter provides an overview of the Open Systems Interconnect model that underlines the wired network standards and discusses the special considerations associated with 802.11 wireless networks.

### 2.2 The OSI Model

The Open System Interconnection (OSI) model describes how information from a software application on one computer moves across a network to a software application on another computer. This model, developed in 1984, is the accepted framework for describing network functions. The model, shown in Figure 1, is composed of seven layers each with its own specific function encapsulated within that layer. This figure shows the subdivision of the Data Link Layer in to the Logical Link Control (LLC) and the Media Access Control (MAC) sub layers. The OSI model captures the core set of network services that are required for transparent communication across heterogeneous networks.

Layer 7	Application		
Layer 6	Presentation		
Layer 5	Session		
Layer 4	Transport		
Layer 3	Network		
Layer 2	MAC	Data Link	LLC
Layer 1	Physical		

Figure 1. OSI Network Model

Conceptually each layer in the model is restricted to communicating with the layer above it, below it, or with the same layer in another application [Sta92]. Figure 2 shows the OSI framework in operation. An application sends data downward through all of the layers to the physical layer where it is sent to its destination. On the receiving end the process is reversed and the message is processed up through the layers until it is sent to the receiving application. Each layer provides services to the layer above and uses the services of the layers below. This layering approach increases the flexibility of the system since individual layers can be modified or replaced without affecting the operation of other layers.

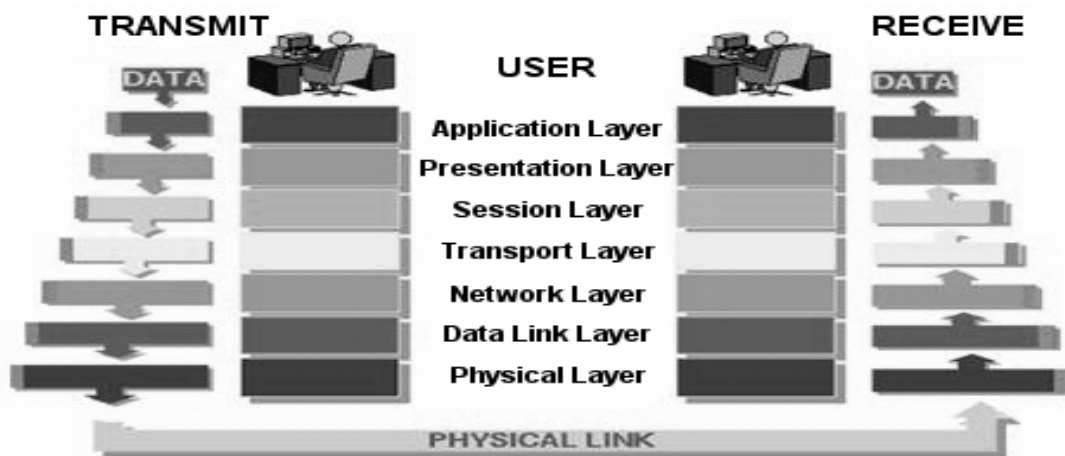

Figure 2. OSI Communication [FoF06]



### **2.2.1 Physical layer**

This layer provides the physical medium. Some examples of this layer are radio (wireless), copper (Ethernet), fiber and coaxial. Each of these is functionally equivalent in that they transmit information or data from one point to another. The difference between each of these is cost, ease of installation, transmission characteristics, and maintenance. It is at this layer that information is converted to and from its binary representation into electrical signals, light pulses, or radio waves.

When transmitting, the physical layer accepts bits from the Data Link layer and converts them into the appropriate signal type (e.g., electrical signals for a wired Ethernet network). At the receiver, the physical layer accepts signals from the physical medium and converts them back into a binary representation for the Data Link layer [Tan96].

This layer also defines the properties associated with the physical layer such as data rates, maximum transmission distances, and types of interfaces.

### **2.2.2 Data Link layer**

The data link layer is divided into two sublayers, the MAC layer, and the Logical Link Control (LLC) layer. The MAC sub layer coordinates access to the physical medium among network nodes. The medium is checked to ensure it is idle prior to granting access to it. The LLC manages error checking and frame synchronization. This layer takes the incoming bits from the physical medium and reorganizes them into frames for the next higher layer.

### **2.2.3 Network layer**

This layer's services include addressing, routing, and congestion control. Congestion control limits the amount of traffic in the network as needed to avoid overwhelming it [Tan96]. A network address is associated with this layer. Based on the network address, routers forward packets from source to destination. The paths used to transmit information in this layer are sometimes referred to as virtual circuits.

### **2.2.4 Transport layer**

This layer provides error free in-order delivery of data. If the data is too large for a single transmission, it is segmented at this layer. Packets are numbered (sequenced) so they can be reconstructed in the event messages arrive out of order. Error free delivery is sometimes achieved by including error-correcting codes along with the data. Error recovery is accomplished by retransmitting data in the event a packet does not arrive or the packet checksum indicates an invalid packet.

This layer also provides flow control. Flow control gives receiving processes the ability to limit the transmission rate so the transmitter does not attempt to transmit more data than the receiver can process [Tan96].

### **2.2.5 Session layer**

This layer establishes, manages and terminates communication connections (also known as sessions) between applications. Session identifiers are added to the messages so applications can differentiate between multiple sessions.

### **2.2.6 Presentation layer**

This layer contains coding and conversion services for the application layer data. Some examples of these services include data representation formats, character representation formats, compression schemes and encryption schemes. This layer is necessary since computers represent numbers and characters in various ways [Tan96]. These schemes ensure that data from the application layer in one system will be useable by an application layer in another system.

### **2.2.7 Application layer**

Applications that require network services access them at this layer. This layer is completely application-specific. Services required by applications not provided by lower layers are implemented here. In this way, application-specific needs can be met without affecting the remaining network model. Applications usually associated with this level are telnet, FTP, and e-mail [Tan96].

## **2.3 Media Access Control (MAC) Protocols**

The OSI model is an example of a protocol stack. A protocol is a set of rules that govern the format of communications between systems. MAC protocols are a set of rules that focus specifically at the MAC layer and the way it operates. There are numerous MAC protocols. Each one is designed to target a specific improvement or to meet a specific need. A few common classes of MAC protocols are discussed in the following sections.

### 2.3.1 Time Division Multiple Access (TDMA)

TDMA protocols divide the transmission medium into time slots or channels. In TDMA, nodes are assigned a time slot and allowed to transmit only during this slot. Figure 3 illustrates the division of the medium into timeslots. By dividing the medium into time slots, nodes cannot be denied a transmission opportunity and are limited to a fixed portion of the available bandwidth.

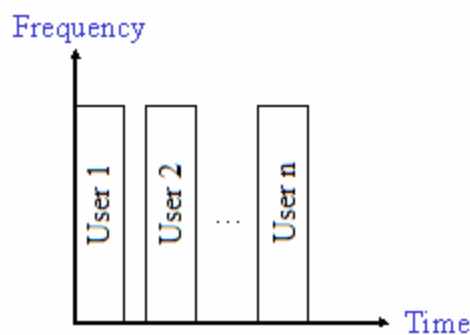

Figure 3. TDMA [Mul06]

Traditional implementations of TDMA configure nodes ahead of time to have an assigned time slot. This assignment guarantees no time slot conflicts between nodes. Because the medium is divided into time slots, once a node has transmitted it must wait a full slot cycle before transmitting again [Tan96].

Reservation-based implementations do not reserve time slots to deployment. Rather, time slots are requested or reserved on an as needed basis. Nodes coordinate by transmitting requests for time slots. In turn, those time slots are reserved and cannot be allocated to other systems until the reservation ends. If a slot is not available, the requester must wait and retry.

Both schemes service many nodes simultaneously, which lends itself to real-time data transmission. To establish time slot boundaries there must be some form of synchronization between the nodes. This synchronization allows nodes to identify where the data lies within each time slot. Without this synchronization, knowledge of where the data was located within a frame could be misinterpreted resulting in wasted transmissions.

Idle nodes also waste resources as shown in Figure 4. If nodes are not actively communicating then their assigned time slot goes unused. This is inefficient since the bandwidth could be better used by permitting active nodes more of the available time slots.

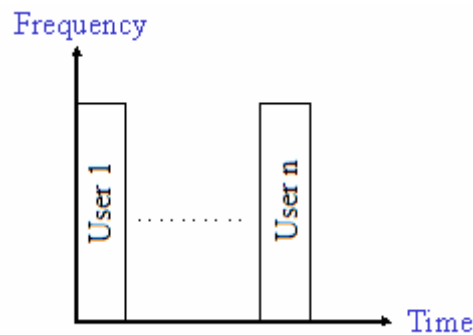

Figure 4. TDMA Idle Timeslots [Mul06]

### 2.3.2 Frequency Division Multiple Access (FDMA)

FDMA protocols, like TDMA, segment the medium for use by multiple nodes. FDMA however divides the channel into frequency ranges rather than time slots shown in Figure 5. Similar to TDMA, FDMA assigns these frequencies ahead of time or on a demand

basis. A common channel frequency is reserved for control functions associated with FDMA.

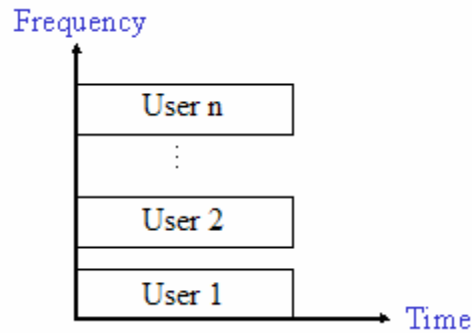

Figure 5. FDMA [Mul06]

FDMA divides a specific frequency range into smaller segments to allocate to connected nodes. Specific frequencies are chosen based on the needs of the application. By dividing the frequency range into these smaller pieces, nodes get a smaller portion of the overall bandwidth. FDMA nodes can use these dedicated frequencies for continuous transmission [Tan96].

A common problem in FDMA is interference between adjacent frequencies. Guard bands, reserved spectrum between node frequencies, prevent interference between nodes on neighboring frequencies. Guard bands introduce overhead since they reduce the amount of available bandwidth. FDMA also suffers similar problems to TDMA in that frequencies not used are a source of waste. These frequencies could be used by active nodes.

### 2.3.3 Code Division Multiple Access (CDMA)

CDMA works by modulating data with a unique spreading code and transmitting it across all frequencies. Spreading codes are binary patterns that modulate a signal and thus spread the original signal across a wider spectrum. By choosing unique codes, each signal is modulated in a way that prevents interference with others. This technique allows multiple nodes simultaneous access to the entire medium unlike TDMA and FDMA. Figure 6 shows how each user or node is spread across the entire frequency range for the entire time.

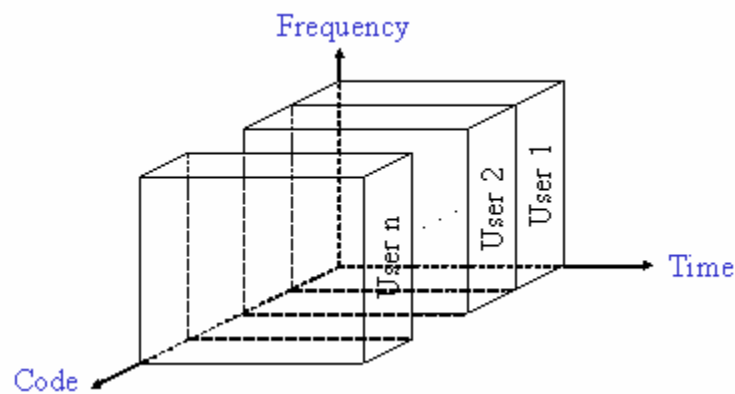

Figure 6. CMDA [Mul06]

To receive in a CDMA system, nodes must know all the assigned spreading codes. Nodes take the received signal and demodulate it with a corresponding spreading code. Once the received signal is demodulated, the original message is recovered. If the received signal does not match any spreading code assigned it is simply discarded [Tan96].

CDMA schemes lead to a more efficient use of the assigned frequency range. Since there is minimal risk of interference due to the unique spreading codes, the complete frequency range can be used by nodes for communication simultaneously. However, the amount of data that can be transmitted is reduced by the length of the spreading code.

#### **2.3.4 Carrier Sense Multiple Access (CSMA)**

CSMA schemes take an entirely different approach to providing media access. CSMA provides access on a demand basis. Nodes that need to access the medium first sense it to determine if it is idle. If it is, the node is allowed to transmit. Sensing is accomplished by monitoring (listening to) the physical medium for communications [Rap96].

Collisions occur when two or more nodes transmit at the same time. The probability of collision increases as more nodes attempt to access the medium. If this happens, the data cannot be interpreted correctly on the receiving end. Even though nodes sense the medium first, there is still some chance multiple nodes will transmit at the same time. This occurs when two or more nodes sense the medium at the same time and each determined it to be idle. CSMA-CD and CSMA-CA are two common schemes that attempt to mitigate collisions in CSMA.

#### **2.3.5 Collision Detection**

CSMA-CD is a collision detection scheme that provides a mechanism to recognize and recover from collisions. In collision detection schemes, all nodes listen while they transmit. If multiple nodes attempt to transmit at the same time, signals will collide



causing a change in the original signals. When this event is detected, a random number representing a backoff period is chosen and the node waits for the specified backoff period before retransmitting. If a collision is detected during retransmission, the backoff is increased and the process is repeated.

### **2.3.6 Collision Avoidance**

CSMA-CA is a collision avoidance scheme. Collision avoidance schemes attempt to prevent collisions rather than detecting them. There are many methods for avoiding collisions but the most common approach is a reservation scheme.

Reservation based schemes require nodes to declare their intent to transmit by first transmitting a Request to Send (RTS) message. When the destination node receives an RTS, it responds with a Clear to Send (CTS) message. Other nodes that receive this RTS/CTS message wait for the specified duration of the transmission before attempting to send their own RTS messages.

By requiring nodes to reserve the medium, collisions can be avoided. In reservation schemes, the only likely collisions occur during the RTS/CTS handshake. Reservation messages add some overhead to the system. If the message to be sent is relatively short, then the addition of the reservation messages is less efficient. However, if the message is relatively large, then the addition of reservation messages is beneficial since retransmitting a large message is costly in terms of time and wasted bandwidth.

## 2.4 Wireless (802.11)

To support multiple access, the IEEE 802.11 wireless protocol includes one mandatory and two optional coordinating functions [SaL01]. The mandatory coordination function is called the Distributed Coordination Function (DCF). The optional functions are the DCF with handshaking and the Point Coordination Function (PCF).

The DCF is used in CSMA based coordination [SaL01]. All nodes with messages must contend with each other for access to the medium. In 802.11, each node prior to transmission chooses a parameter called a backoff value. This value indicates the next time this node will attempt a transmission. Backoff values generally range from 0 to  $2^n - 1$  ( $n=5$ ) unless collisions are detected. If collisions are detected,  $n$  is incremented. If more collisions are detected,  $n$  is again incremented until  $n$  reaches a predetermined upper limit.

Figure 7 provides a graphical layout of the DCF period. In this figure, D represents the distributed interframe space or DIFS period. MPDU is the MAC protocol data unit or the data packaged in headers for transmission. S represents the short interframe space or SIFS period. A represents the acknowledgement message. CW represents the contention window or the period where nodes contend for access to the medium.

Before transmitting, nodes sense the medium to determine if it is idle [SaL01]. If the medium is idle, the node transmits its message. If the medium is busy, an initial backoff value is chosen. Once this value is selected, a node waits until this value is 0 before transmitting. To decrement this value, nodes monitor the channel for a DIFS period. If

the channel is idle the entire time, the backoff value is decremented. If the channel is busy at any point, the value is not decremented and the channel must be idle for another DIFS period for the backoff value to be decremented. Following transmission, a SIFS period elapses before the receiving node responds with an acknowledgment packet.

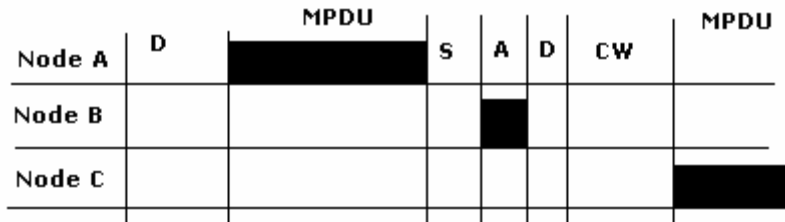

Figure 7. IEEE 802.11 DCF [80206]

As a part of DCF, nodes include a value, called a network allocation vector (NAV), in the message header that indicates the length of time needed to complete communications. This value indicates the amount of time the transmitting node requires the use of the channel to include the acknowledgement from the receiving node. Nodes receiving these messages will immediately wait until the time indicated by the NAV before decrementing their backoff values again. Using backoff values and NAV fields, the DCF attempts to avoid collisions. This function is however prone to collisions if nodes cannot hear each other's transmissions.

As an optional function, DCF with handshaking attempts to avoid collisions from nodes that cannot hear each other, commonly referred to as hidden nodes [SaL01].

Handshaking notifies other nodes of an intent to communicate. A node with a packet to transmit sends a request to send (RTS) message. If the destination node is ready to

accept a packet, it sends a clear to send (CTS) reply. All nodes that receive either the RTS or the CTS message are aware of who is allowed to transmit and how long that transmission will take. Nodes not allowed to transmit remain idle until the NAV period indicated in the RTS/CTS message has expired before attempting another RTS. The initial RTS messages are subject to collisions. Figure 8 shows a DCF period with optional handshaking.

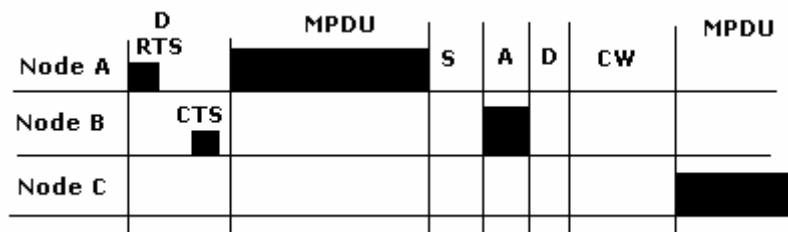

Figure 8. IEEE 802.11 DCF with handshaking [80206]

The other optional function is the PCF. The PCF supports time-sensitive information. This function divides the medium access into a contention-free period and a contention period. The contention period uses DCF while the contention-free period uses PCF. In a PCF period, nodes needing to transmit notify the point coordinator. The point coordinator gives each node an opportunity to transmit for a specified amount of time. This polling cycle lasts a specified amount of time and then the network returns to the DCF period before repeating this cycle.

## 2.5 Wireless Issues

Even though CSMA techniques allow multiple nodes to communicate simultaneously, wireless implementations suffer from a limited ability to detect the collisions that these

techniques try to avoid. Hidden nodes are another aspect of wireless networks that hinder collision detection. These two problems reduce the effectiveness of wireless networks.

### **2.5.1 Collision Detection**

One big problem is the inability to detect collisions during transmission. Unlike wired nodes, wireless nodes cannot transmit and receive simultaneously. A radio typically has one antenna for both transmitting and receiving. Even if one antenna were dedicated to receiving, it would still only detect its own transmissions due to the close proximity and high relative signal strength of its own transmitting antenna. Because wireless nodes only have one antenna, they must transmit a full message before switching to receive mode. Therefore, they cannot actively listen for collisions while they transmit. With no ability to monitor during transmission, collisions are likely to occur.

One type of collision occurs when a node completes transmitting and switches to receive mode. If it detects a signal, it is possible two nodes detected an idle medium and began transmitting at the same time and one node finished transmitting before the other. The node that detected the signal will treat it as a collision and retransmit. The other node will not recognize this as a collision even though one has occurred since it will not detect a signal when it switches to receive mode.

### **2.5.2 Hidden Nodes**

Another situation where a collision is not detected comes from the so-called hidden node problem [SaL01]. A hidden node exists when three or more nodes are not in range of

each other's transmissions such as in Figure 9. This network in this figure is a network with four nodes A, B, C, and D. The circles represent the transmission and reception ranges of each of the nodes.

Consider nodes A and C. A and C cannot receive each other's transmissions. If A and C transmitted to B at the same time, a collision would occur but neither A nor C would know there was a collision since they are out of range of each other's transmissions. This would also happen if node C were transmitting to node D rather than node B.

Another example is the hidden receiver. Suppose node D wants to transmit to node C and node B wants to transmit to node A. Both node D and node B sense the medium as idle and begin. In this example node C will not receive the transmission since node B's and node D's transmissions will collide.

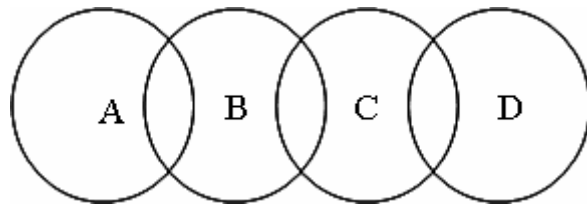

Figure 9. Hidden Nodes

## 2.6 Current Real-time and wireless research

Real-time wireless research has concentrated on two main areas, reservation-based and contention-based schemes. Contention based approaches are typically used in distributed wireless networks while reservation based approaches are found in fixed wireless

networks where a centralized coordinator is used. Protocol research using both these techniques as well as others is discussed in this section.

### **2.6.1 Reservation based protocols**

To improve the performance of real-time systems, Adaptive Acquisition Collision Avoidance Multiple Access Common Transmission code (AACACT) [LLF01] uses a combination of spreading codes and RTS techniques. Recall that RTS/CTS messages are used to reserve the medium. Nodes transmit these reservation messages and only the intended receiving node is allowed to access the channel. Spreading codes (cf., Section 2.3.3) provide simultaneous access to the medium.

The medium is divided into multiple channels with multiple spreading codes. One spreading code serves as a common code used by all nodes for RTS messages. The remaining codes are used by nodes for multiple access. To choose a unique spreading code, nodes monitor all in-range communications and choose a spreading code that is not being used by other neighboring nodes.

When a node has a message to transmit, it initiates an RTS message to the intended node. The RTS message is intended to eliminate collisions from hidden nodes. If the RTS message is successfully delivered, a CTS message is returned. This CTS message does not use the common code but instead uses its own unique spreading code. Thus, once a RTS message is successfully received all future communications are assured of no collisions. Furthermore, since the reply message begins using a unique spreading code only the initial RTS message is subject to collision.

With these techniques, AACA-CT effectively eliminates the problems of hidden nodes. By listening to neighbors to determine available spreading codes, the system as a whole can operate with fewer overall codes. Since nodes that are sufficiently far enough apart cannot hear each other, they will not collide when using the same spreading code. By effectively eliminating collisions due to hidden nodes, throughput in the system is increased. Figure 10 shows the performance increase associated with AACT over other common protocols. By increasing throughput, real-time performance may also improve.

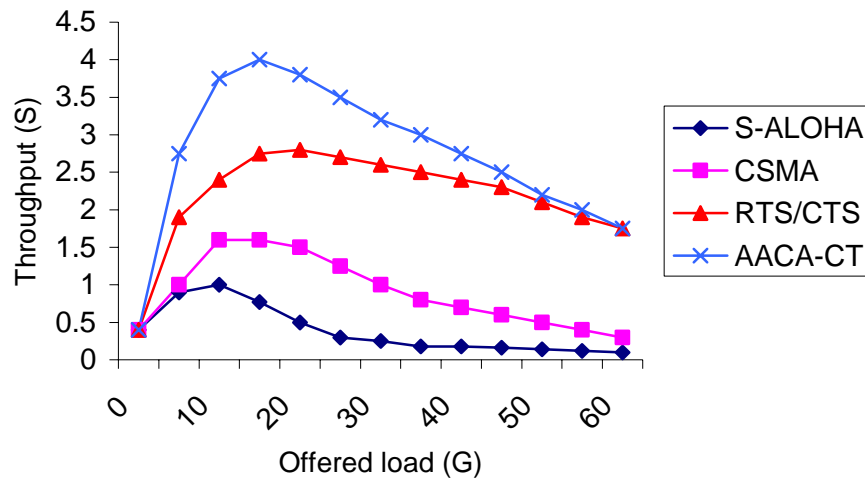

Figure 10. AACA-CT Performance Improvement [LLF01]

Other protocols also use an RTS/CTS handshaking process including [FAM03], Interleaved CSMA (ICSM) [JMM03], [CGL00]. Each of these implementations target specific areas of the RTS/CTS mechanism to improve performance. Through the addition of a feedback tone, nodes signal the requesting nodes they can proceed with transmission [CGL00]. This tone also eliminates problems from hidden nodes. By transmitting this feedback tone throughout the communications process, all nodes within



range of the receiver can sample the channel for this tone. Nodes that sample the channel and detect the feedback tone backoff since other nodes are transmitting and they would interfere with those transmissions even though they may not be able to detect them.

Hybrid Channel Access (HCA) [WaG03] changes the structure of the handshaking process from one of sender initiated to a receiver initiated process. This change prevents collisions at the receiving end by giving priority to the receiver since it has better knowledge of contention around it.

The RTS/CTS implementation in Queue-driven Cut-through Medium Access (QCMA) [RKK04] gives nodes that forward packets priority access to the medium by allowing forwarding nodes to piggyback an RTS message on an acknowledgement (ACK) message. Thus, forwarding nodes can reserve the channel more frequently than others can. The piggybacking of RTS messages allows these forwarding nodes to bypass the period where nodes contend for channel access and proceed to transmit the message that requires forwarding.

Similar to the RTS/CTS portion of AACA-CT, Priority MAC [JLW04] is also reservation based. In Priority MAC, all nodes are given a number to indicate their transmission priority. This protocol uses 802.11 as a basis. A classification period in the protocol identifies nodes with the highest priority messages to send. To initiate communications, nodes transmit a burst signal during the classification period. The length of the burst signal is proportional to the priority assigned to that node. High priority nodes transmit longer bursts than lower priority nodes. Once the burst has been transmitted, a node

monitors the channel. If no other burst signals are detected then the node listening has the highest priority and may proceed to the identification phase and begin transmitting. If another burst is detected, another node has higher priority and listening nodes defer their transmissions. This process repeats until the highest priority messages are delivered and subsequent levels of priority may contend for the channel. Figure 11 shows as the system load increases, higher priority traffic (video and voice) sees much higher throughput than lower priority data.

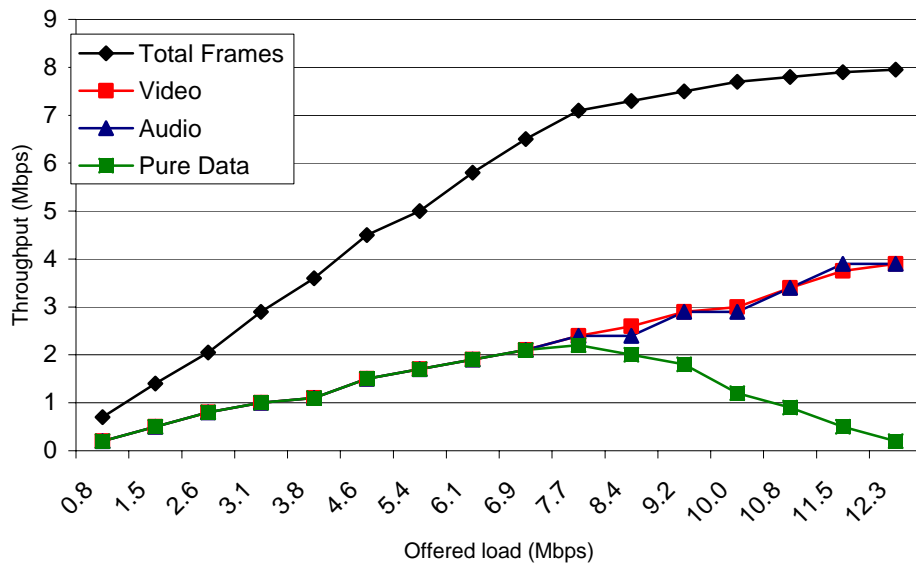

Figure 11. Priority MAC Performance Improvement [JLW04]

Other implementations recognize the benefit of using RTS/CTS messaging depends on a variety of conditions. Using RTS/CTS handshaking when packet size is small or not using RTS/CTS when packet size is large can both be inefficient. To minimize the costs associated with RTS/CTS handshaking, the performance of the network may be improved

by allowing nodes to determine whether to turn RTS/CTS on or off based on current network conditions [SCC03], [JRK03].

### **2.6.2 Contention based protocols**

To reduce collisions during the reservation period many protocol techniques divide the period into mini-slots. Collisions are less likely due to more reservation slots. The Dynamic Hybrid Partitioning (DHP) [RPS00] gives priority to delay sensitive sources. In other reservation protocols, all sources contend for access each time they have a message to transmit.

To provide for priority traffic, DHP segments the reservation period into an idle mode segment and a contention segment. These segments are further divided into mini-slots similar to other protocols to reduce collisions during the reservation period. The contention segment is used for all new reservations, both delay sensitive and non-sensitive, while the idle mode segment is reserved for already accepted but idle, delay sensitive sources. If a delay-sensitive reservation request comes in and an idle segment slot is available, then a slot is reserved for that source. By assigning slots to delay sensitive nodes, these nodes no longer have to contend for transmission.

To manage these segments DHP uses an algorithm to determine the number of mini-slots in each segment. An idle segment is allowed to have no mini-slots since there might be no delay sensitive sources. On the other hand, the contention segment will never be zero since this segment is used by all sources wishing to reserve a slot for transmission. The number of contention slots is initially one and idle slots zero. Contention slots increase

as collisions are detected. If a collision is detected with one slot then contention slots are doubled. If collisions are still detected, the number of slots is increased by four. As idle slots are detected, the mini-slots are reduced.

A careful balance is necessary to control the efficiency of both idle and contention mini-slots. The parameter,  $R$ , controls the number of idle mini-slots.  $R$  is the number of consecutive frames an idle mini-slot will be reserved for a given source. Setting this parameter too high causes large delays since a delay sensitive source may have to wait up to  $R$  frames before it can transmit. On the other hand setting this value too low will have the least delay but can waste bandwidth if a source has a significant amount of time between transmissions.

The performance of DHP comes in the form of constant channel access times for delay sensitive sources. The channel access delays of DHP are shown in Figure 12. This constant channel access for delay sensitive nodes means priority traffic has almost instantaneous access for delivery and lower delays for priority traffic.

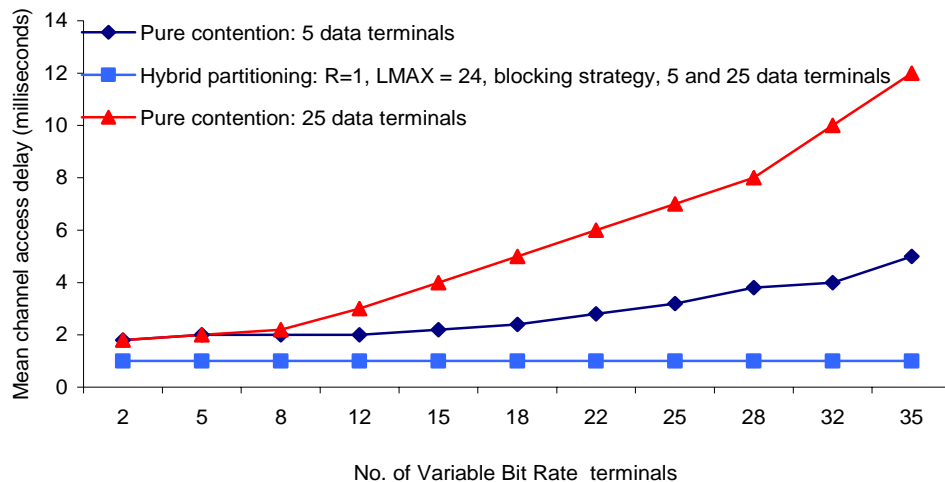

Figure 12. DHP Channel Access Performance Improvement [RPS00]

As the number of delay sensitive nodes increases, delay in DHP remains continuous whereas pure contention delay is grows at a steady rate. By providing priority to delay sensitive sources, DHP improves the overall performance of real-time systems.

Dynamic 802.11 [CCG00] dynamically adjusts the backoff algorithm to match current network conditions. Nodes monitor the network to estimate the number of nodes, average number of consecutive empty slots and average collision cost. These estimates determine the probability of sending a message. By continuously monitoring the network, nodes use these estimates to optimize the backoff algorithm to keep the performance of the network as close to optimal as possible. Figure 13 shows the effect dynamic adjustment has on the protocol capacity. By adjusting the backoff algorithm based on current network conditions, Dynamic IEEE 802.11 keeps the performance of the network near the theoretical bounds.

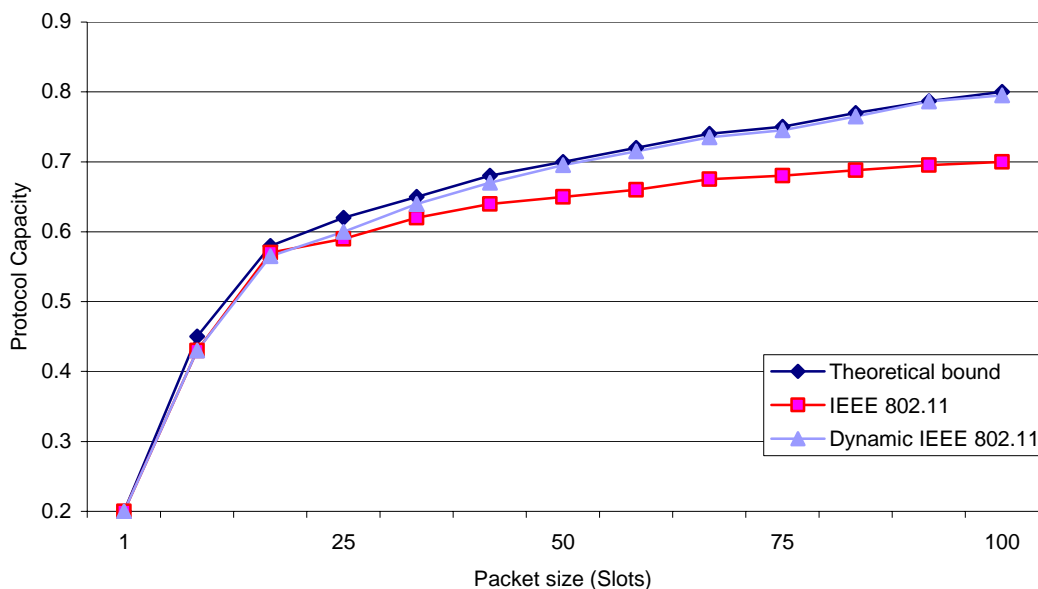

Figure 13. Dynamic IEEE 802.11 Performance Results [CCG00]

Fast Collision Resolution (FCR) [KFL03] improves performance by managing the contention window. FCR enhances the 802.11 protocol in several ways. The initial minimum backoff value is smaller than 802.11 and the maximum backoff value is higher than 802.11. The contention window size is also increased for nodes that are in either a collision state or a deferring state. Finally, backoff timers are reduced exponentially when a predetermined number of consecutive idle slots are detected.

This reduction in backoff values provides the fast collision resolution. By exponentially reducing these backoff values, nodes are able to resume transmissions following collisions much sooner. The effect of this reduction algorithm is a higher system throughput as shown in Figure 14.

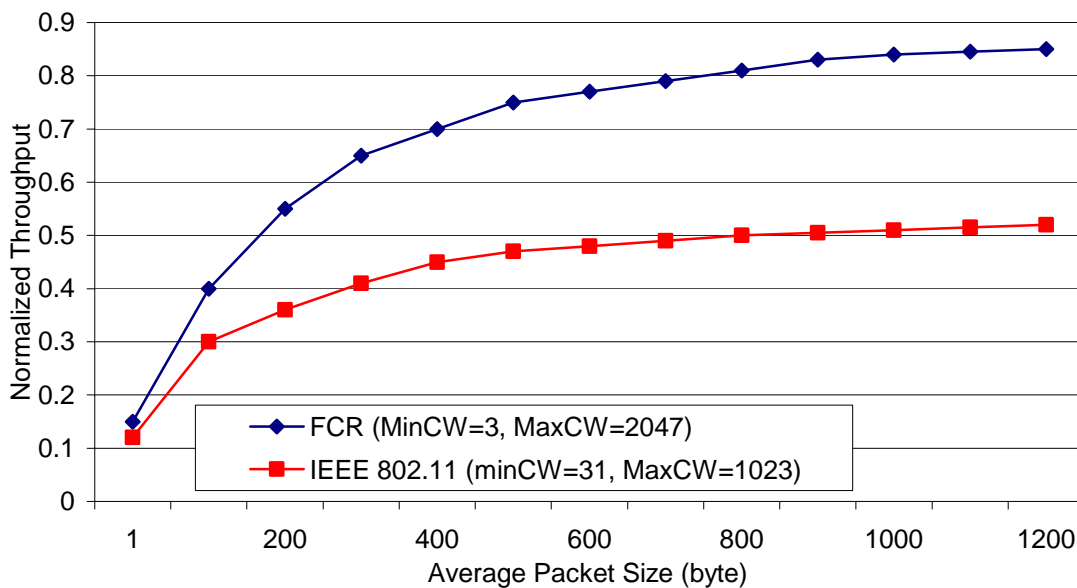

Figure 14. Fast Collision Resolution Performance Results [KFL03]

### 2.6.3 Strict Delivery Bound

Real-Time Medium Access Control (RT-MAC) [Bal99] takes a different approach to real-time deadlines. While other protocols focus strictly on reducing delays or increasing throughput as a means of bounding real-time delays, RT-MAC employs a bounded delivery time after which information will be discarded.

In this system, a deadline for the transmission is specified. At specific points during the transmission process, this deadline is checked. If at anytime it is determined that the transmission will not meet its deadline, the packet is discarded. By discarding packets that will not meet their deadline, system load is reduced. Another feature of RT-MAC is its Enhanced Collision Avoidance (ECA). To reduce collisions in the system, nodes append to the current transmission a backoff value representing the next time it will transmit. Collisions are reduced by monitoring these values and avoiding transmissions during these times.

By discarding packets that have expired deadlines, packets are guaranteed to be delivered in a bounded time or not be delivered at all. Compared to 802.11, RT-MAC performs significantly better as the numbers of nodes increase as shown in Figure 15. As shown, 802.11 tends to reach a maximum throughput at about the .5 offered load and maintains this throughput over the remaining loads. However, as the number of nodes increases the throughput of 802.11 starts to drop significantly. RT-MAC on the other hand also peaks at the .5 offered load .but is able to maintain much higher throughput even as the numbers of stations starts to increase. Through the indication of next transmission values

and the discarding of late packets, collisions in this scheme are reduced and the overall throughput of the system is increased.

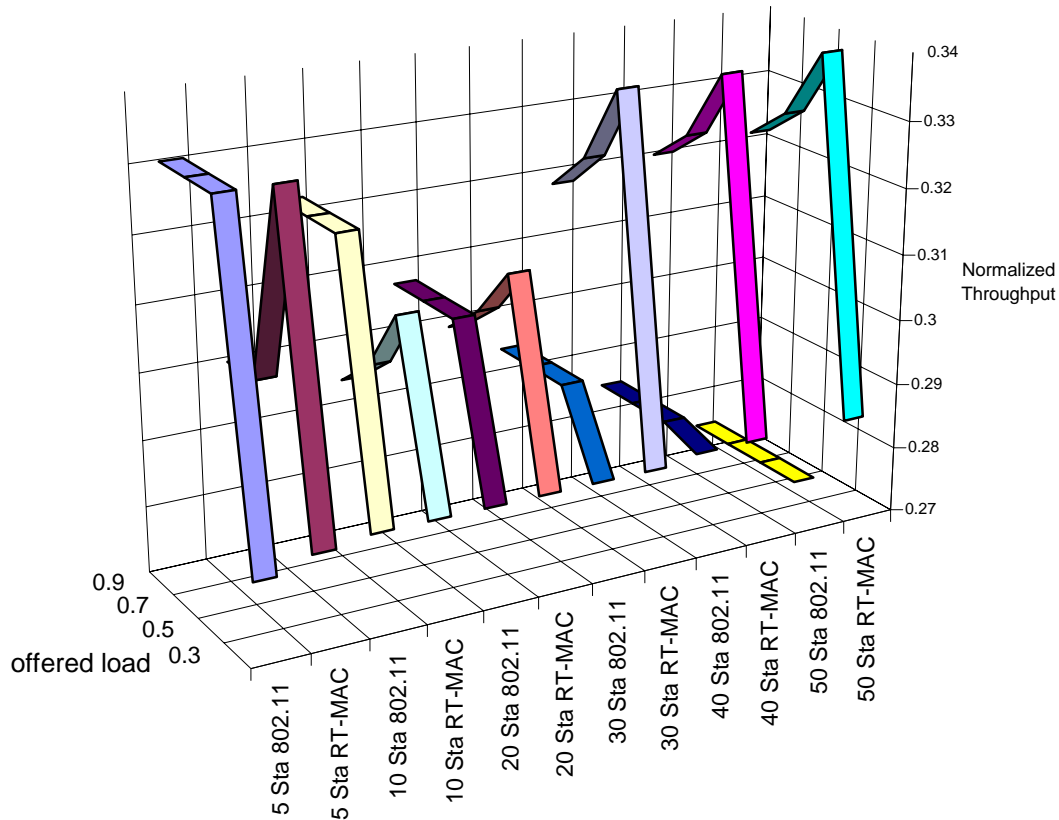

Figure 15. RT-MAC Performance [Bal99]

## 2.7 Summary

This chapter discussed current research into real-time and wireless protocols. The aim of much of this research was to improve throughput. By increasing throughput in the system, delays experienced by nodes are also decreased resulting in higher on-time delivery rates. Using techniques such as channel reservation and contention period modifications, these protocols enhance the real-time performance of their underlying



system. While increasing throughput is beneficial, throughput enhancements alone are not enough to ensure critical or real-time message delivery.

### 3. Methodology

#### 3.1 Introduction

The most common measures of performance for computer networks are throughput and mean delay. Real-time networks, that is networks where message delivery times are critical, are not primarily concerned with throughput. Rather, performance is measured based on the timely delivery of information. In real-time networks, if information is not delivered within a predetermined amount of time, it will likely be replaced with more up-to-date information or not transmitted at all. This chapter discusses implementation issues of real-time wireless networks. It presents the research problem definition, objectives, and solution methodology. First, the problem is defined followed by the research objectives. Finally, a solution methodology that includes system boundaries, parameters, evaluation techniques, experiment design, and validation is described.

#### 3.2 Problem Definition

Small wireless sensor networks are increasingly being used to transmit messages in a variety of applications such as battlefield sensors, emergency response, and environmental monitoring. Messages in these applications have a real-time aspect. That is, messages have an upper bound on their delivery times. If a message is delivered outside of this bound, the data either has become irrelevant or has been replaced with current data.

Much of real-time protocol research is concentrated on improving network throughput as a means of increasing responsiveness to real-time messages. This increase in throughput is generally accomplished by means of channel contention based mechanisms or reservation based mechanisms. The goal of both of these techniques is to reduce the number of collisions (i.e., more than one node transmitting at a time) in the system. Minimizing collisions naturally results in higher throughput through increased network efficiency.

Delays experienced by messages vary due to a variety of system conditions, some of which can be managed through protocol enhancements. System conditions such as message generation rate, number of nodes and collisions are just a few. These conditions increase the likelihood that messages will have to spend a significant amount of time in the network. The longer a message spends in the system the more likely that its deadline will be missed and the message discarded with the consequent waste of bandwidth. This process of message expiration reduces the message on-time delivery rate for messages. While much of the protocol research yields higher throughput, however this does not ensure that real-time messages are delivered in a timely manner.

The ability of these enhanced protocols to achieve collision reduction is partially based on either an assumption of network synchronization or the actual implementation of synchronization within the network. This is a costly approach in terms of either hardware or software modifications of the protocol. If software provides synchronization, there is the overhead of messaging between nodes to maintain this synchronization. Depending on the architecture, the message overhead may negate much of the benefit gained from

the enhancement. If hardware is used, the cost is associated with manufacturing processes which produce higher quality nodes. An asynchronous solution that provides real-time performance enhancements is preferred.

### **3.2.1 Goals and Hypothesis**

The goal of this research is to improve the real-time performance of wireless sensor networks.

The hypothesis of this research is that the lack of differentiation between packets is the primary reason delivery deadlines are missed for high priority messages. Differentiating between low priority and high priority messages, then, should improve real time performance. By providing service to high priority packets before low priority packets, high priority packet delay times should be reduced and on-time delivery percentages of high priority traffic should increase.

### **3.2.2 Approach**

To improve real-time performance, message type information (i.e., low/high priority flag) is included by the application layer. The underlying Media Access Control (MAC) protocol acts on these priority flags and an overall message deadline is established. The message deadline is used to determine the length that messages are allowed to remain in the system. Messages whose time in the system exceeds this value are discarded. The priority flag allows the system to distinguish between high and low priority messages enabling high priority messages to be transmitted first.

It is expected that including message type information and modifying the MAC layer to act on this information, high priority message delay will be reduced. This reduction in delay for high priority messages will, in-turn, result in a higher on-time delivery rate for high priority messages.

By establishing message deadlines, system workload is reduced since nodes discard expired messages rather than continue to attempt transmission. This reduction in traffic load allows more messages to be received on time since the bandwidth expired message would use is freed up for other valid messages.

By including both message type and message deadlines, nodes can make intelligent use of the transmission channel. This information results in lower delays for high priority messages, increased on-time delivery rates for high priority messages and increased real-time performance.

### **3.3 System Boundaries**

The System Under Test (SUT) is the set of components and software required to transmit wireless sensor messages. These components consist of a processor, application, MAC, transmitter, medium, and receiver as shown in Figure 16. Embedded applications generate messages and forward them to the MAC layer for transmission. These messages act as the offered load. The MAC delivers the message to the transmitter, which places the message on the medium. The medium “carries” the message to the receiver. The receiver either forwards the message to another node or accepts the message if it is the end node. The Component Under Test (CUT) is the MAC.

## SUT- Real Time Message Transport System

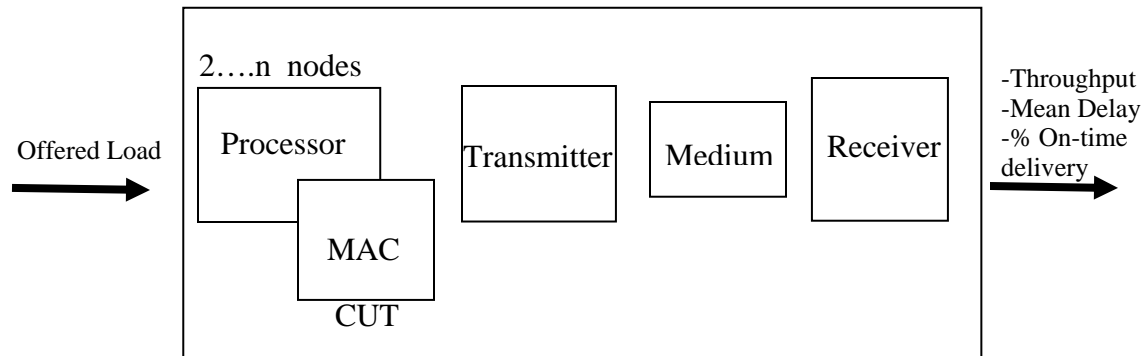

Figure 16. System and Component Under Test

One standard message format is used. This system assumes there is no interference from outside the network.

### 3.4 System Services

This system provides only one service, the wireless delivery of messages between nodes.

The possible outcomes of this service are success and failure.

A successful outcome occurs when an error free message arrives at the receiving node prior to the expiration time of the message. All other results are failures. Failures can be due to the following reasons:

- No message received
- Message with errors is received
- Error-free message received after message has expired

### **3.5 Workload**

The workload of this system is messages for transmission. A single 28-byte message format is used for all experiments. This message format includes a field to be used to indicate message priority. The message format is chosen based on its inclusion in the base application for the hardware. This message structure is also already incorporated making modifications for the research simpler.

### **3.6 Performance Metrics**

The performance metrics are:

**Throughput** – Expressed in bits per second, throughput is the number of bits transmitted divided by the time taken to transmit the data. Throughput is an indication of how many messages the system can handle under a given set of conditions. Experiments calculate throughput with and without message modification. These values are compared to determine if message modification has any impact.

**Mean delay** – This metric is typically used in the performance analysis of all types of networks. This delay is measured in seconds and is the average amount of time a message spends in the system.

**On-time delivery percentage** – This is the ratio of messages delivered on time to the total number of messages generated.

### 3.7 Parameters

The parameters for this system are:

- Number of nodes – The number of nodes has a direct impact on collisions
- MAC layer – The MAC layer coordinates access to the medium
- Radio Signal Strength – The strength of the radio signal determines the maximum distance nodes can be placed apart.
- Topology – The topology determines whether nodes can hear other's transmissions.

Workload parameters include:

- Message generation rate – The rate messages, both low and high priority, arrive to the system affects offered load.
- High Priority Generators – The number of nodes that generate high priority traffic.
- Message Size – Message size along with message generation rate determine offered load.
- Message Deadline – Message deadlines affect how long messages are allowed to remain in the system. This can either increase or decrease the amount of traffic in the system needing to be transmitted.



### 3.8 Factors

The factors for this experiment and their respective values are:

- MAC
  - Unmodified (Baseline) – All messages in this system will be treated equally using a backoff value from 0-31. Metrics from this will be used to determine baseline performance metrics.
  - Modification 1 (MAC 1) – The MAC acts on message deadlines and message types. This MAC chooses backoff values for high priority messages using the range (0-3).
  - Modification 2 (MAC 2) – The MAC acts on message deadlines and message types. This MAC chooses backoff values for high priority messages using the range (0-7).
  - Deadline
    - Low – 250ms
    - High – 500ms
- High Priority Generating Nodes
  - 2 nodes – 10% of each node's traffic is high priority traffic
  - 6 nodes – 10% of each node's traffic is high priority traffic
- Message generation rate –
  - 10% of normalized throughput
  - 50% of normalized throughput
  - 90% of normalized throughput
  - 200% of normalized throughput

### **3.9 Evaluation Technique**

The evaluation technique is direct system measurement. This technique is chosen due to the dynamic nature of collision along with the availability of hardware. Using direct system measurement, a more accurate interaction between factors can be observed.

The research hardware is validated against the performance of an 802.11 network. This validation ensures the research platform performs similar enough to the 802.11 protocol to serve as a basis for research modifications. OPNET, a simulation environment, is used to validate the research platform.

Analytical analysis is not used as the primary evaluation technique due to the dynamic nature of collisions. This technique also has much lower accuracy when compared to direct system measurement.

### **3.10 Equipment Configuration**

A specific sensor node is chosen due to the availability of the equipment. The hardware is the MICA2, 7 MHz processor, 900 MHz radio, wireless node. An external exponential distribution mechanism emulates packet arrivals for each experiment and each node. All nodes are positioned so they can receive transmissions of all other nodes.

#### **3.10.1 Hardware**

The configuration chosen for validation consists of three nodes separated by arbitrary distances. Two nodes are arranged side-by-side approximately 12 inches apart. The third

node is used as a common receiver. This node is approximately 12 inches from the center of the other two nodes. This configuration is used to validate that the system performs similar to 802.11 type architectures.

The configuration chosen for the research experiments has eleven nodes and is illustrated in Figure 17. Ten nodes are arranged into two rows of five nodes each, again with arbitrary distances between them. Approximately six inches separate each node with six inches between the two rows. A central receiver is again used and is placed approximately 12 inches in front of and centered on the first row.

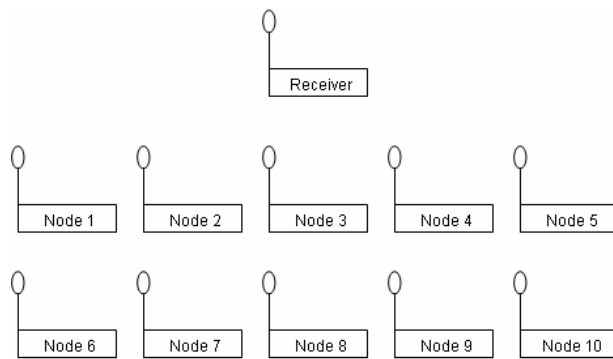

Figure 17. Experiment Configuration

### 3.10.2 Software

The sensor nodes use TinyOS, a scaled operating system specifically tailored for sensor nodes. SMAC, a prepackaged application within TinyOS, is used the basis for all experiments and modifications to the MAC protocol

Initial modifications to SMAC make it operate similar to the 802.11 protocol.

Transmissions only occur after the backoff value reaches zero. Backoff values are

decremented after an idle slot is detected and a queue is added to the MAC layer. This set of changes is the basis for validation experiments.

Three more modifications are necessary for the actual experiments. The modified SMAC from the validation effort is used as a basis for these changes. The first change is in the application layer where messages are generated. For this change, the on-board random number generator determines the messages priority level, high or low. Space in the message structure is already available to indicate the priority with a simple flag SMAC. The first of these is message deadline. Just prior to message transmission the deadline of the message is checked and enforced. If the deadline has not been exceeded the message is allow to be transmitted otherwise the message is discarded.

The final change involves both a low and high priority backoff value. The normal backoff range for messages in this system is from 0 to 31. Low priority messages will continue to use the normal backoff range of 0 to 31. The value for the high priority backoff will range from 0 to 3 for the first set of experiments, MAC 1, and 0 to7 for the second set of experiments, MAC 2. Messages will use the backoff values associated with their priority level. In this manner, high priority messages, having a smaller backoff range, will be transmitted prior to low priority messages. Baseline experiments are conducted with only priority indicators and deadlines changes.

### **3.11 Experimental Design**

The experimental design for this research is full factorial with four factors. Each experiment consists of a unique combination of factors, which allows the effect of each

factor to be determined as well as factor interaction. This technique also allows an isolation of experimental error from variation due to factors. The number of experiments, n, using a full factorial design with four factors and three replications is

$$\begin{aligned}n &= a * b * c * d * 3 \\ &= (3 \text{ MAC layers}) (2 \text{ deadlines}) (2 \text{ generators}) (4 \text{ workloads}) (3 \text{ replications}) \\ &= 48 \text{ experiments} * 3 \text{ replications}\end{aligned}$$

### 3.12 Summary

This experiment determines the impact that MAC modifications for high priority messages and message deadlines have. Applications flag messages as either low or high priority while the MAC layer processes high priority messages before low priority messages and enforces message deadlines. Experiments use the factors of MAC layers, message generation rate, priority generating nodes, and deadlines to determine the effect these factors have.

It is expected that the lack of message type differentiation is the primary factor for message delivery times being missed. By indicating the message priority and providing processing at the MAC layer for high priority messages before low priority messages, high priority end-to-end delay will decrease and on-time delivery percentages will increase. Data collection and analysis are presented in the next chapter.

## 4. Data and Analysis

### 4.1 Introduction

This chapter presents the data and analysis of this research. By adapting the MAC layer to process high priority messages ahead of lower priority ones, end-to-end delays for high priority messages are reduced, leading to a higher percentage of on-time delivery of priority messages. These improvements are accomplished without affecting throughput for either type of message.

### 4.2 System Validation

The first experiments verify the sensor hardware and underlying protocol are performing like an 802.11 wireless network. An OPNET built-in wireless model is constructed to validate the research hardware and software. The configuration of the OPNET wireless model matches the research hardware validation configuration outlined in Section 3.10.1. Two performance metrics, throughput and end-to-end delay, are compared between the two networks. Since the built-in OPNET model configuration settings cannot be set to the level of the sensor hardware, the shape of the performance curves are used as a means of validation.

Four main levels are selected for offered load. These levels take both the simulation environment and the hardware environment from a lightly loaded stable system (0.2) to a heavy loaded unstable system (1.2). The offered load levels are 0.2, 0.5, 0.7, 0.8, 0.9, 1.0, and 1.2. These loads are chosen for system validation purposes only and not as a means of validating specific loading level performance. A different set of loading levels

are chosen for research experiments as the validation loads are meant to determine that the general system behavior is like that of an 801.11 network.

For OPNET, the system parameters are a 1 Mbs data rate, a queue size of approximately 10 packets and a 1024-byte packet size. For the MICA2 hardware, the system parameters are a 4480 bps data rate, a queue size of 10 packets and a 28-byte packet size. Loading levels for this research were normalized to this (4480 bps) data rate.

#### **4.2.1 End-to-End (ETE) Delay**

The validation experiments resulted in the ETE delay increasing over the pre-selected offered loads for both systems. This behavior is normal and expected for typical networks. As the load offered to the system increases, the amount of time messages spend in the system also increases because messages are generated at a greater rate while the transmission capability remains at a constant fixed rate. As the message generation rate approaches the data rate of the channel, message queuing and buffering must be used. Once queued, messages wait until the channel and transmission mechanism become available before being transmitted. By remaining in queue for any length of time, ETE delay starts to increase. The higher the offered load the more likely a message will queue and queue for a longer period resulting in higher ETE delays. The ETE measurements from both OPNET and the MICA2 validation experiments are shown in Figures 18 and 19.

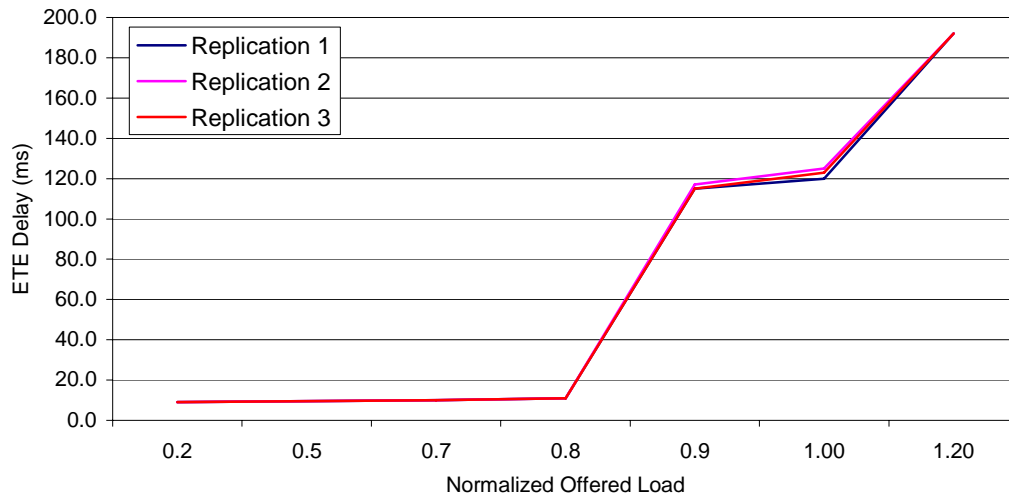

Figure 18. OPNET ETE Delay Results (802.11)

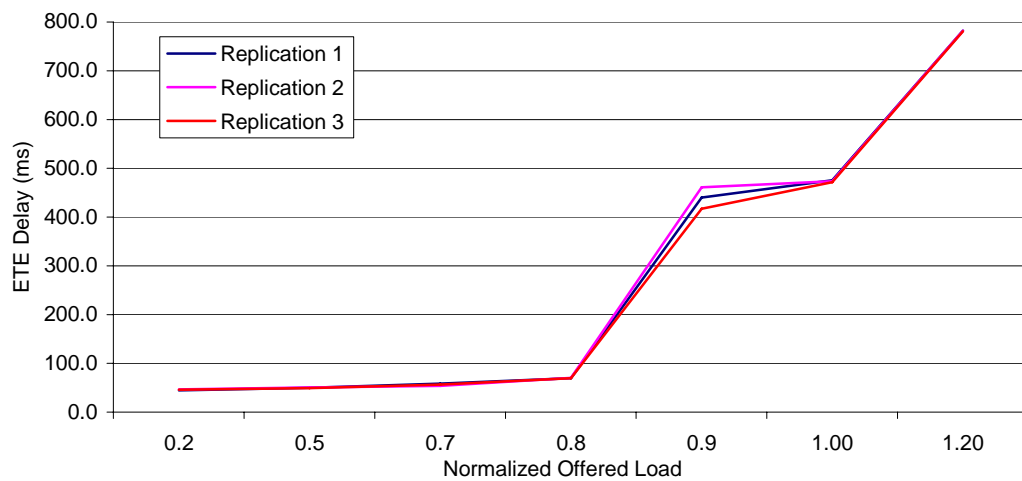

Figure 19. MICA2 ETE Delay Results

Each system remains relatively stable until the 0.8 offered load. At loads above 0.8, both systems quickly become unstable. From this point on, any increase in load further increases system instability. Although built-in OPNET models do not support the levels used by sensor hardware, the trend of both systems is identical. Based on the ETE delay plot comparisons, the MICA2 sensor network is behaving similar enough to an 802.11 network to be used as a basis for the research experiment.



## 4.2.2 Throughput

Throughput is the second metric used for validation with an increase in throughput exhibited over the offered loads for both systems. This behavior is also normal and expected. As the offered loads to these systems increases, throughput increases as a result. Throughput continues to increase up until an offered load of 0.9. When the systems reach this point, the amount of traffic generated combined with the contention for the channel limits the throughput to less than the system capacity. Loads from this point on will tend to begin to decrease throughput in the system. Because there is so much contention for the channel, fewer transmissions are completed. The throughput plots of both OPNET and MICA2 systems are shown in Figures 20 and 21.

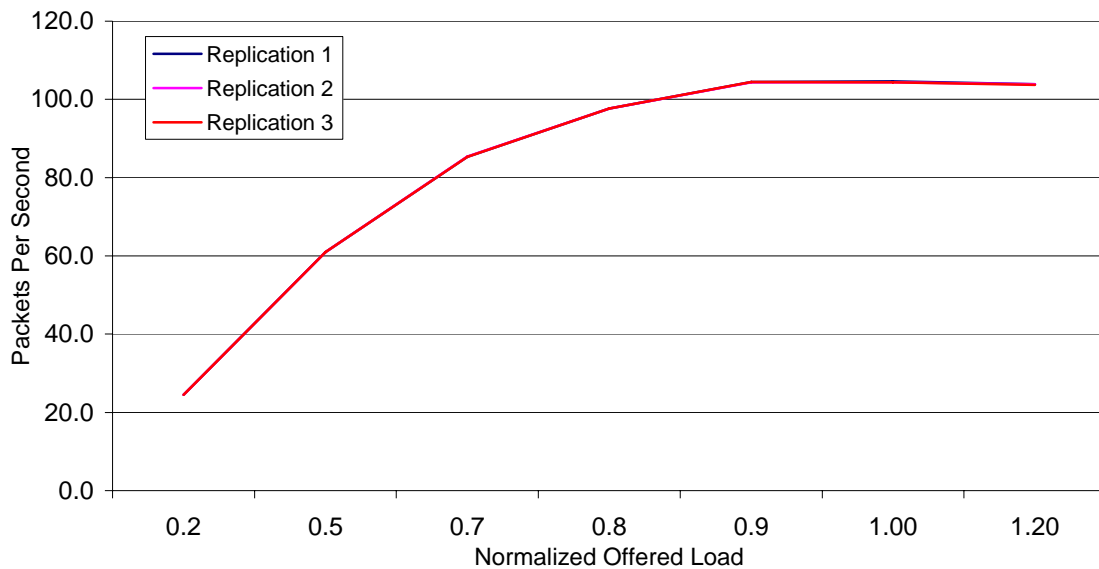

Figure 20. OPNET Throughput Results (802.11)

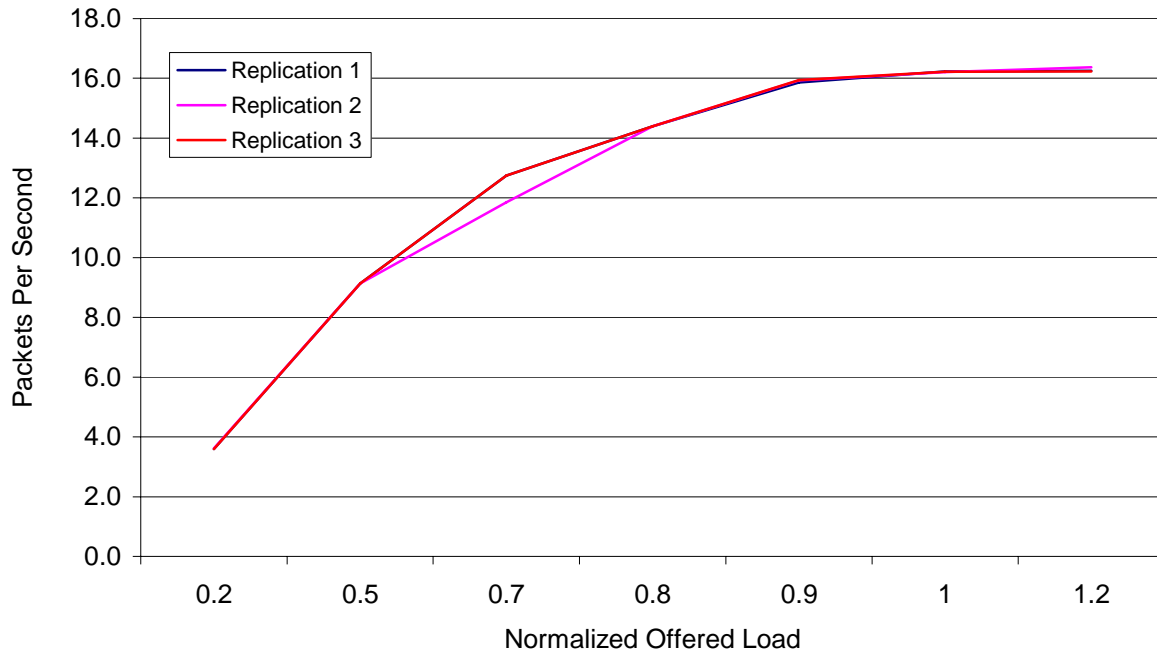

Figure 21. MICA2 Throughput Results

The trend in the curves from both systems is nearly identical. Based on a shape comparison of the throughput plots, the MICA2 hardware is behaving sufficiently like an 802.11 network to be used as a basis for the research experiments.

### 4.2.3 Summary

The validation experiments determine whether the hardware and protocol are operating similar to an 802.11 network. The results from both systems are graphed and the performance metrics are compared. The similar trends exhibited by both OPNET and the MICA2 hardware in both the ETE delay plot and throughput plot provide assurance that the sensor hardware and protocol are operating closely enough to an 802.11 network to be used as a basis for the remaining research experiments.

### 4.3 Experimental Analysis

The results of the performance metrics ETE delay, on-time delivery, and throughput are individually examined to determine the impact, if any, on performance improvements to the system. These results allow conclusions to be drawn from the experimental data.

MINITAB, a statistical program, is used to compute and present the experimental results. A combination of Analysis of Variance (ANOVA) tables, confidence intervals, and factor interaction graphs are used to determine whether the protocol improvements are a result of system modifications or due to other factors not part of the experiment. These also provide insights into which factors, or combinations there of, contribute the most to performance improvement.

ANOVA tables provide a breakdown of each factor and factor combination and its effect on the overall experiment. The resulting table from the ANOVA provides numerical data representing each factor and its specific effect. This table also summarizes how much of the observed change was a direct result of each factor and how much is not accounted for by the model, or error. Model adequacy is presented in a value called R-Squared. This value is the percentage of the total variation accounted for by the factors of the model (excluding error). A high R-Squared indicates experimental factors account for most of the variation in the experiment.

Confidence intervals indicate the range of values a factor is likely to take on. Ninety percent confidence intervals are used for this research. Taking an average of the means from the experimental data and building a confidence interval for them provides a range of values the mean will have 90% of the time. Comparing the confidence intervals shows

whether the means of the baseline metrics overlap with the metrics from the modified system. If the confidence intervals overlap, it is an indication that the values from the modified system could have likely occurred in the baseline system as well. This indicates the results are not due to improvements or modifications to the system. Thus, it is shown using confidence intervals, that the outcome of an experiment is statistically different from the baseline experiment.

Factor interaction graphs show the effect of each factor as it relates to the metric under study. These graphs also provide a means of showing any specific factor levels that contribute significantly to performance improvements. These methods provide a means of determining which factors and factor levels contributed the most to performance improvements. With this statistical support, conclusions are formed from the experiment data.

#### **4.3.1 ETE Delay**

The experiments showed in a significant decrease in high priority message ETE delay when compared to high and low priority messages from an unmodified system across all offered loads. The improvements range from a 50 percent decrease in ETE delay at low loading levels (0.1) to 10 percent at heavy loads (2.0).

The ability to deliver high priority messages with 50 percent less delay of low priority messages is significant. Since high priority messages are arriving more often, decision relating to this data must decrease as well. The modifications to the MAC layer are allowing, in most cases, critical messages to be delivered first. By allowing critical

message delivery first, the delays experienced by those messages remain consistently lower. These results can be especially useful in military applications where decisions times are critical.

Figures 22-29 show the outcome of the ETE delay experiments. In the legend of each figure, LP stands for low priority and HP for high priority. In addition, MAC 1 represents the MAC modifications where high priority backoff values are chosen in the range of 0-3 while MAC 2 represents modifications allowing high priority backoff values in the range of 0-7. Compared to an unmodified system and low priority traffic, ETE delay for high priority messages is consistently lower.

The ETE delay 90 percent confidence intervals are listed in Table 4 in Appendix A. This table shows that both modified MAC levels exhibit statistically different results from the baseline experiments at loads up to 2.00. Based on this, the trend of modified high priority traffic, shown in Figures 22-29, outperforming baseline high priority traffic is statistically supported. Table 4 also shows that MAC 1 and MAC 2 experiments are only statistically different in the 500 ms deadline configuration with offered loads less than 0.9 since the remaining confidence intervals overlap. This indicates the two modifications are performing too closely to determine if one is better than the other. However, they are statistically better than the baseline system. Figures 22 and 23 show the ETE results of 2 nodes generating high priority traffic.

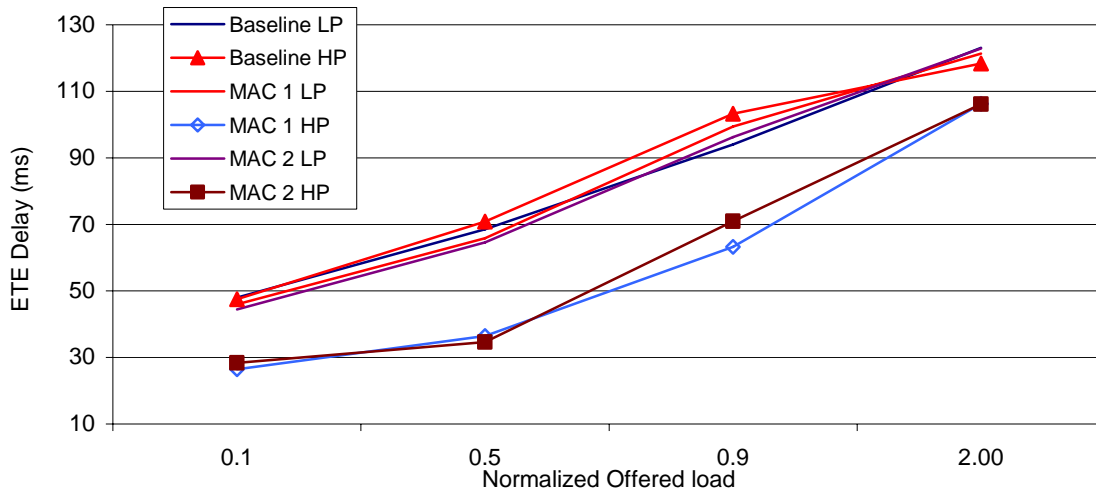

Figure 22. ETE Delay using 2 High priority nodes and 250ms Deadline

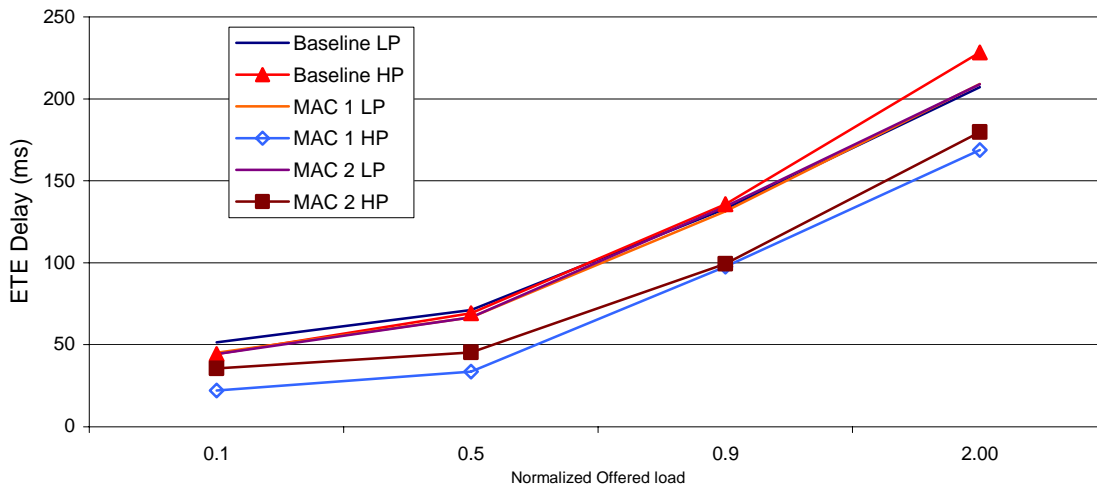

Figure 23. ETE Delay using 2 High priority nodes and 500ms Deadline

Both modified MAC levels exhibit similar behavior across all offered loads. MAC 1 (backoff from 0 to 3) results in a slightly lower ETE delay over MAC 2 (backoff from 0 to 7). This is expected since MAC 1 chooses slightly smaller values and is therefore transmitting its high priority packets quicker. The 250 and 500 ms deadlines have little impact on ETE delay differences between the two MAC modifications other than

increasing average delay. Figures 24 and 25 more clearly show the difference in individual results.

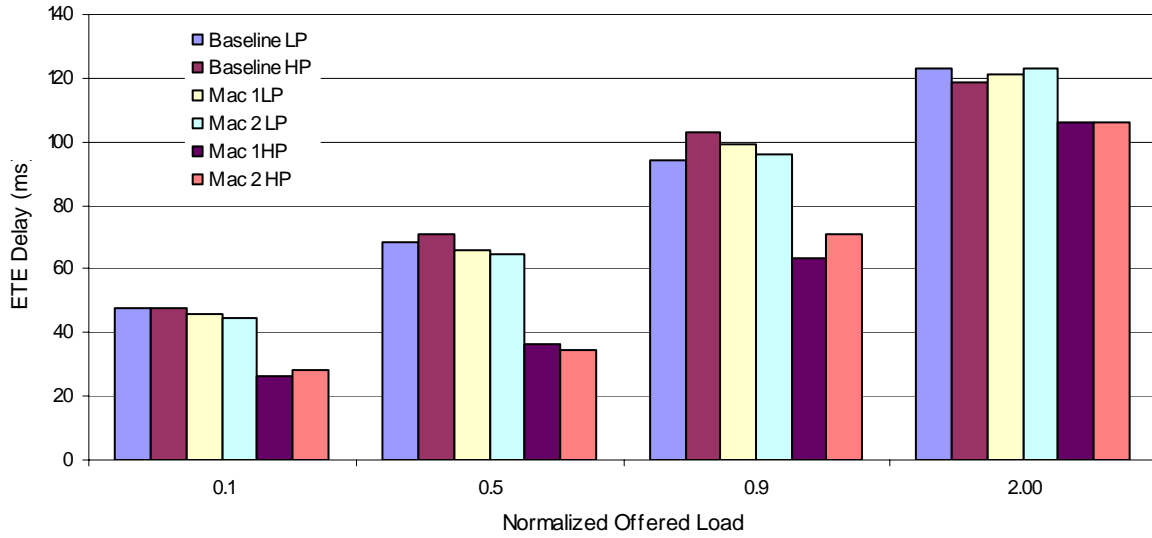

Figure 24. ETE Delay using 2 High priority nodes and 250ms Deadline

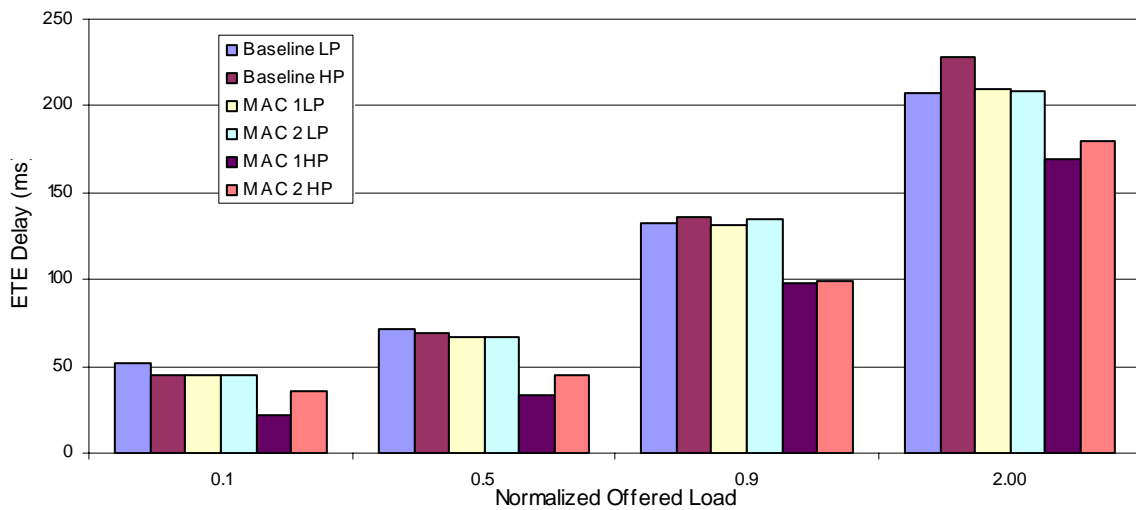

Figure 25. ETE Delay using 2 High priority nodes and 500ms Deadline

In Figures 24-25, the ETE delay for low priority traffic in each configuration is relatively equal at the respective loading levels. In addition, high priority traffic in the baseline system is performing similar to low priority traffic. High priority traffic in the baseline system is arriving at the same time or later than lower priority traffic.

What this suggests is if an event that generates a significant amount of low priority traffic occurs along with a critical event, the critical event traffic must queue in tandem with the low priority traffic. This can lead to excessive delays depending on how much low priority traffic was generated and where the critical event occurred with respect to the low priority event. With this delay, decisions relating to this information must wait until the data is processed. Figures 26-29 present the ETE delay with six high priority generating nodes.

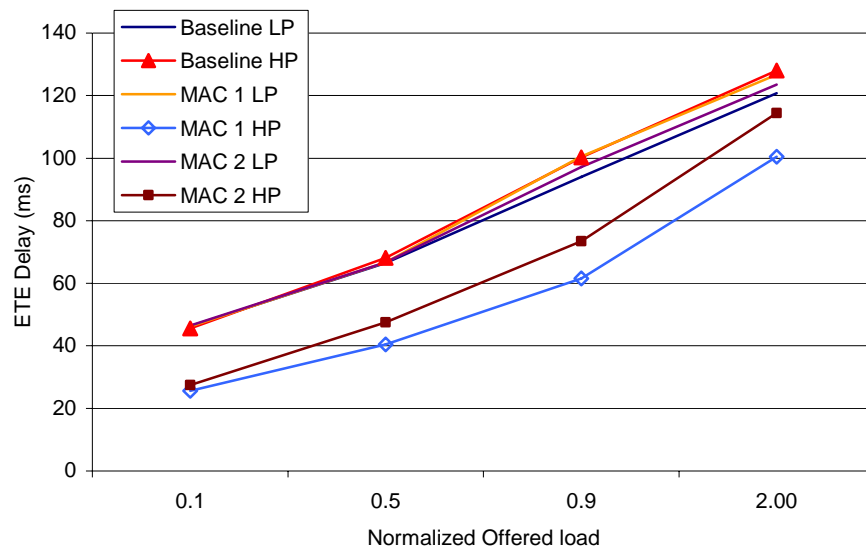

Figure 26. ETE Delay using 6 High priority nodes and 250ms Deadline



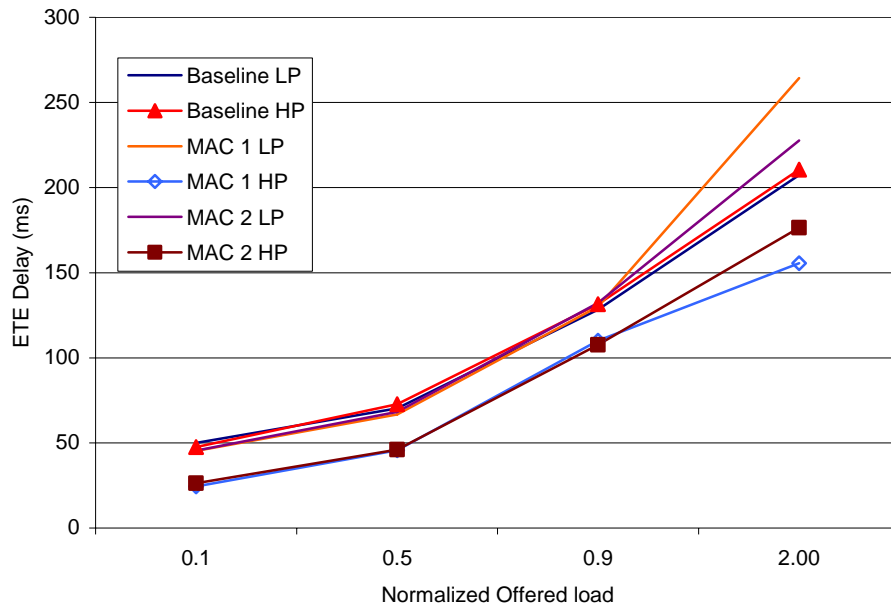

Figure 27. ETE Delay using 6 High priority nodes and 500ms Deadline

Figures 26-27 show the ETE delay performance with six nodes generating high priority messages. Again, the modifications to the MAC allow high priority messages to be delivered considerably sooner than low priority messages. At the 500 ms deadline, MAC 1 has a slight advantage over MAC 2. This advantage disappears at the 250 ms deadline since by discarding packets sooner, the ETE delays in both configurations is becoming much closer.

Figures 28-29 again show that the performance of low priority traffic in all configurations is relatively equal. High priority traffic in the baseline system is also performing about the same as low priority traffic. In addition, both modified MAC levels are outperforming the baseline system consistently.

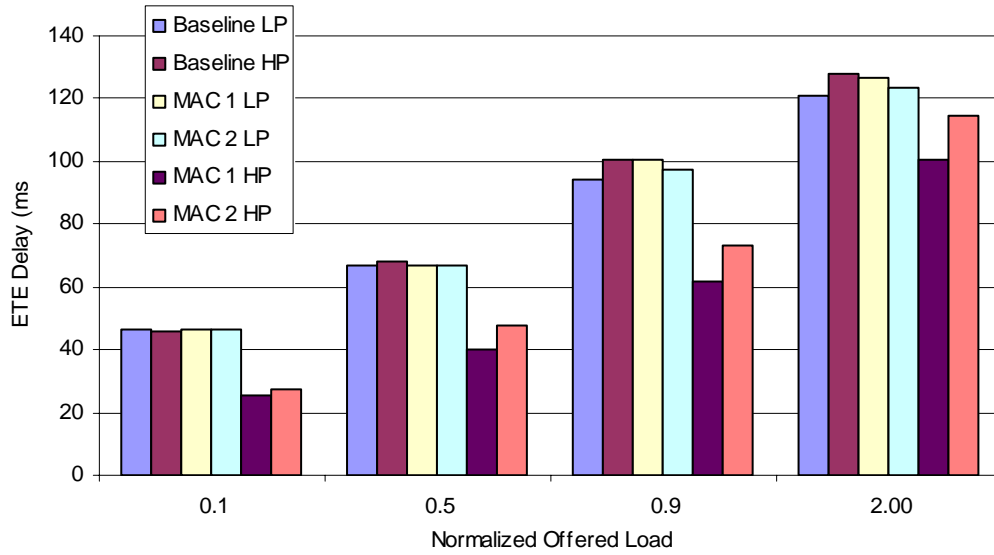

Figure 28. ETE Delay using 6 High priority nodes and 250ms Deadline

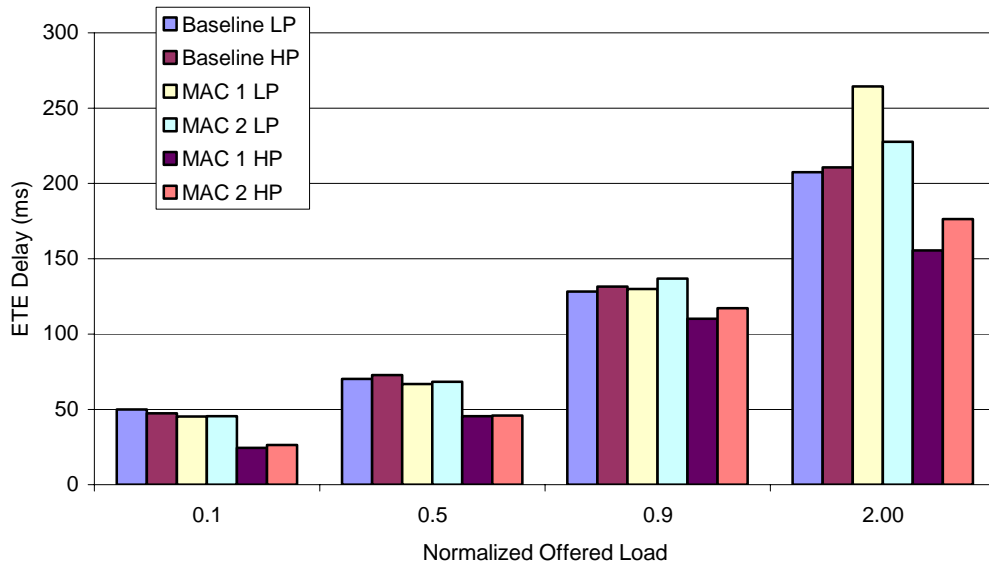

Figure 29. ETE Delay using 6 High priority nodes and 500ms Deadline

By adapting the protocol to transmit high priority messages prior to low priority messages, the delays high priority messages experience are significantly reduced. MAC 1 is delivering lower delays to high priority messages compared to MAC 2. There is little difference in delay results between two and six high priority generating nodes.

### 4.3.1.1 ANOVA

To use an ANOVA the underlying assumptions of the ANOVA must be validated. The ETE delay experimental data is formatted and used to generate the graphs for validating ANOVA assumptions. Since the system is unstable at the last offered load (2.0), it is removed from validation. Figure 30 provides the graphs used in validating these assumptions.

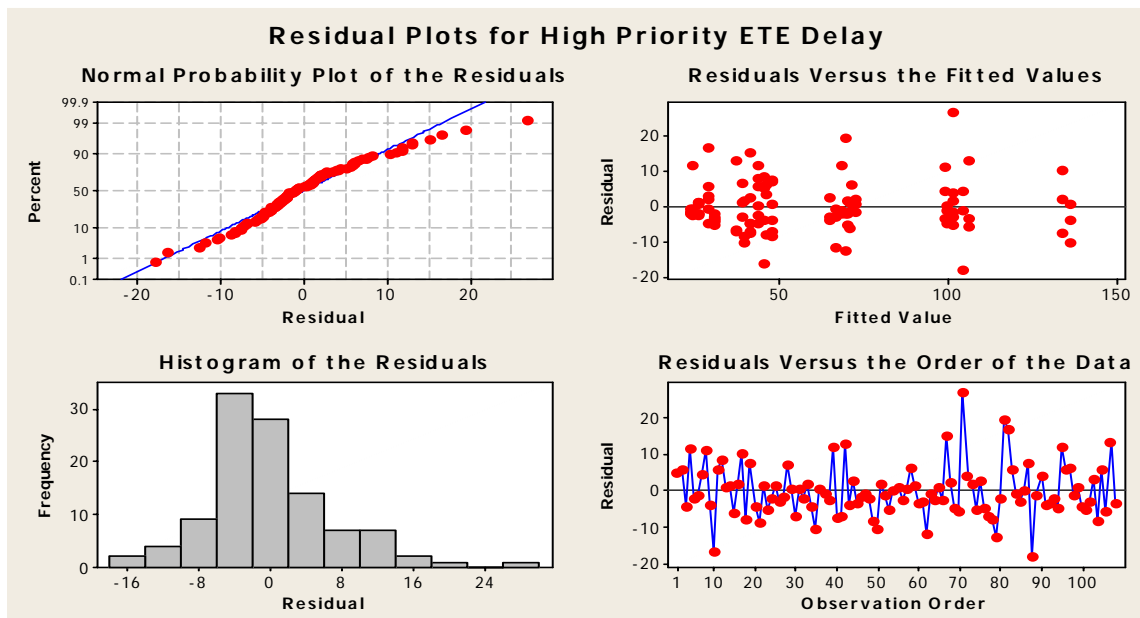

Figure 30. ETE Delay ANOVA Validation

To support the assumption of randomness, fixed location and fixed variance, the lag plot (top right) and run sequence plot (bottom right) must appear random. These two graphs indicate this assumption is satisfied since no pattern is distinguishable in these two graphs. To satisfy the assumption that residuals are from a normal distribution, the normal probability plot (top left) should be linear and the histogram (bottom left) should be bell shaped. Even though the histogram is not entirely bell shaped, it still appears to

be normally distributed, satisfying the fixed distribution assumption. The normal probability plot also indicates that the fixed distribution holds since it is approximately linear. With the underlying ANOVA assumptions satisfied, the remainder of the ANOVA output can be used.

#### 4.3.1.2 Factor Interactions

The ANOVA data for ETE delay experiments is listed in Table 1. This table has the output of factors whose effects could not be directly attributed to the experiment removed. An ANOVA table with all factors for ETE delay is shown in Table 5 of Appendix A. Table 1 shows the effect each remaining factor and factor combination has on the experiment. In this table, MAC consists of the three MAC levels, baseline, MAC 1 and MAC 2. OL is the three remaining offered loads to the system, 0.1, 0.5, 0.9. WL is the two levels of high priority nodes, two high priority generating nodes, and six. Deadline has two levels of message deadlines, 250 ms, and 500 ms.

Table 1. ETE Delay ANOVA

Source	DF	Seq SS	Adj SS	Adj MS	F	P
MAC	2	17686.6	17686.6	8843.3	154.32	.000
OL	2	75572.8	75572.8	37786.4	659.40	.000
Deadline	1	4163.2	4163.2	4163.2	72.65	.000
MAC*OL	4	735.0	735.0	183.7	3.21	.016
OL*Deadline	2	6860.7	6860.7	3430.4	59.86	.000
Error	96	5501.2	5501.2	57.3		
Total	107	110519.5				
S=7.52968		R-Sq=95.02%	R-Sq(adj)=94.45%			

From the Seq SS column it is clear that the two main factors that affect the ETE delay the most are the MAC and OL. This column represents the total amount of variance in the

model that this factor explains. This value is spread across the degrees-of-freedom for the particular factor.

The offered load, given the nature of the experiment, must be varied and cannot be deemed a primary consideration with respect to performance improvements. This leaves MAC as the primary factor in the reduction of ETE delay for high priority messages.

Figure 31 graphs the main effects and their influence on high priority ETE delay.

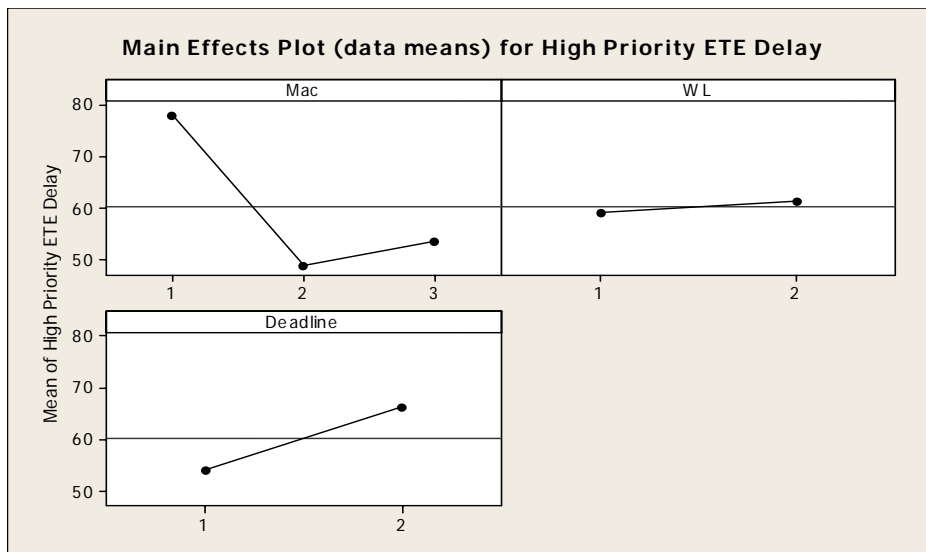

Figure 31. ETE Main Effects

Figure 31 indicates the biggest factor affecting ETE delay is the MAC. The top leftmost graph in Figure 31 shows the effects of each MAC on high priority ETE delay. Level one of this graph is the baseline system in which there is no modified treatment of high priority messages. Level 2 is MAC 1 and level 3, MAC 2. Clearly, MAC 1 has the largest impact on decreasing ETE delay with MAC 2 having slightly less effect than MAC 1. Table 1 indicated the MAC level has a significant impact on the ETE delay

improvements and Figure 31 indicates that level 2 (MAC 1) has the most impact on for this factor.

The workload (WL) graph in Figure 31 shows the number of high priority generating nodes. Level 1 uses two nodes while level 2 uses six. There is negligible difference between the two factor levels and their impact on ETE delay. Thus, WL has little impact on the overall ETE delay improvement in the system. This supports what is shown in Table 1 given that WL was removed since it had a high p-value indicating the effects were due to randomness rather than the factor itself.

The deadline graph contrasts the effects that the deadline factor is having on ETE delay improvements. Level 1 represents a deadline of 250ms and level 2 a 500ms deadline. The graph shows that the higher deadline is resulting in a large increase in ETE delay. This is a direct result of allowing messages to remain in the system longer. While these deadlines are having an impact on ETE delay, they are not a major contributor to the performance improvements.

#### **4.3.1.3 Summary**

Based on the experiment data, ANOVA, confidence intervals, and interaction graphs, the MAC modifications incorporated in this research provide a significant decrease in ETE delay for high priority messages. There appear to be no considerable interactions between any of factors of this experiment leaving only the MAC modifications as the main factor in the real-time performance improvements.

### 4.3.2 On-Time Delivery

The next performance metric to be evaluated is on-time delivery. A significant increase in on-time delivery rates for high priority messages is observed at high loads and in unstable network conditions. On-time delivery is directly related to ETE delay. Since ETE delay performance improved, a similar improvement is expected here. The increase in on-time delivery at such high loads ensures critical messages are delivered in all situations. The confidence intervals for on-time delivery are listed in Table 6 of Appendix B.

Table 6 shows the confidence intervals overlapping at an offered load of 0.9. This means that even though improvements are beginning to appear in the system at this point, they are not statistically different from the baseline. However, at the 2.0 offered load and both deadlines, the confidence intervals do not overlap with the baseline system. It is at this point where the MAC modifications become statistically different from the baseline, supporting the tendency, shown in Figures 32-35, that the MAC modifications are having a significant impact on performance improvements.

The most impact is seen in the 250 ms deadline configuration with an offered load of 2.0. In this configuration, the high priority traffic is experiencing between 34 and 45 percent higher on-time delivery rates over the baseline configuration. While the improvements noticed in on-time delivery occur only in the higher loading levels of this research, significantly lowering the deadlines would likely cause these effects to show up at light loading levels as well. Figures 32-35 present the on-time delivery data plots.

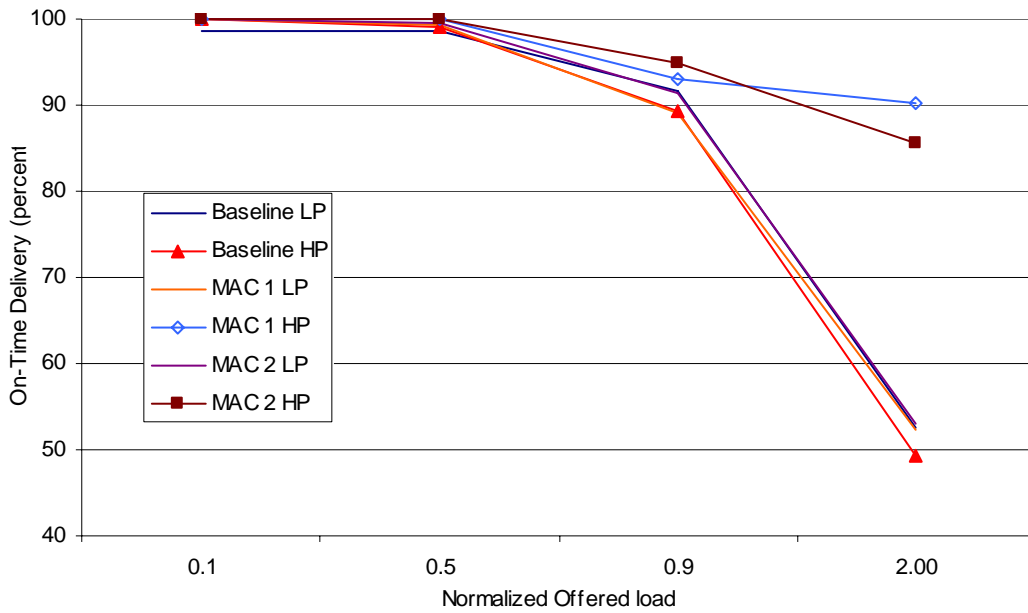

Figure 32. On-Time Delivery using 2 High Priority Nodes and 250ms Deadline

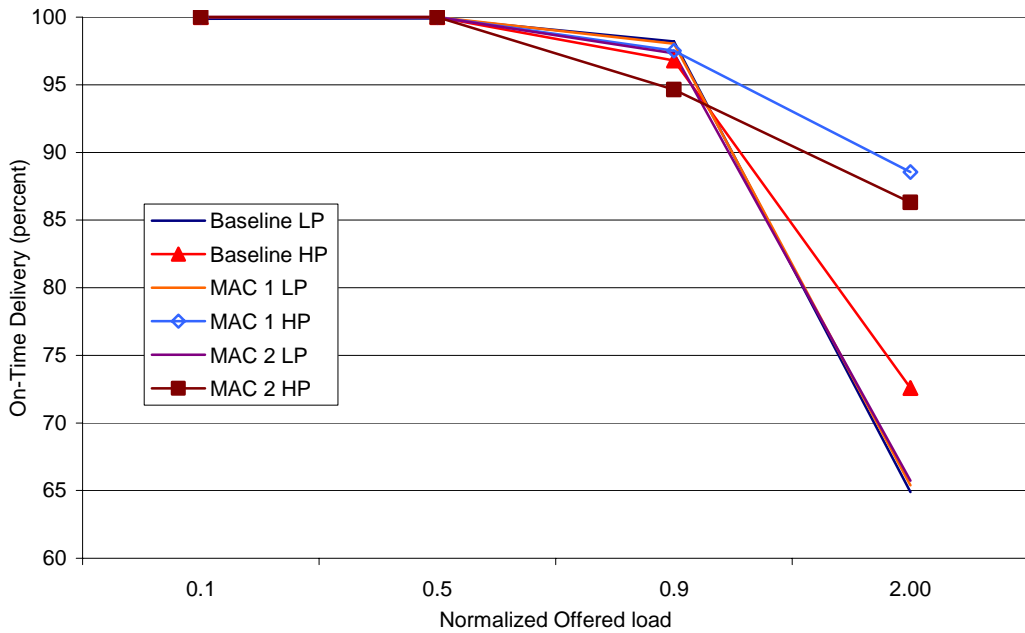

Figure 33. On-Time Delivery using 2 High Priority Nodes and 500ms Deadline

There is a significant increase in on-time delivery for high priority packets in the 250ms deadline configuration shown in Figure 32. The 500ms deadline configuration in Figure



33 also shows an improvement of on-time delivery, but the deadline increase also improves lower priority traffic as well. The point at which these improvements are noticed is in an unstable portion of the system.

This system is unstable at this point because the system as a whole is generating more traffic than can be processed by the channel and receiver. Even though the system is unstable, the high priority on-time delivery rate is still very high. This ability to maintain a high delivery rate at such an unstable load ensures that high priority messages are arriving even under worst-case network conditions.

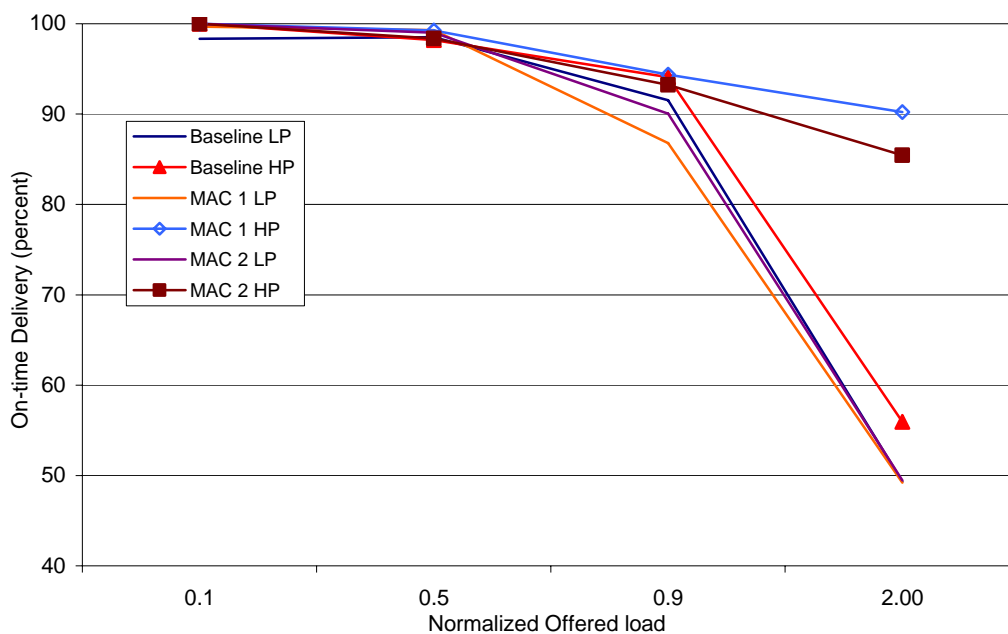

Figure 34. On-Time Delivery using 6 High Priority Nodes and 250ms Deadline

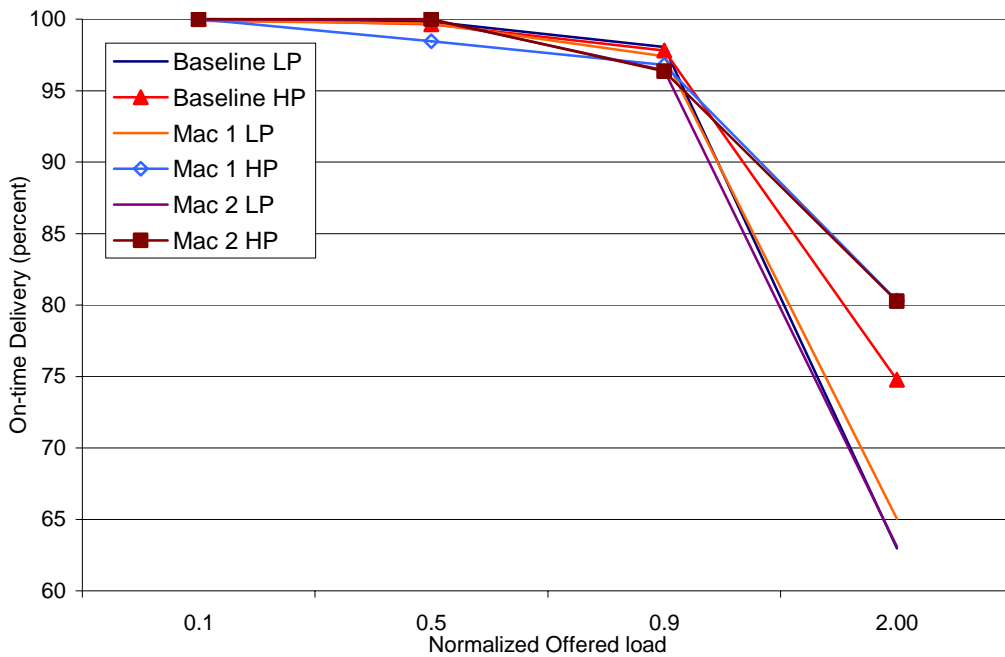

Figure 35. On-Time Delivery using 6 High Priority Nodes and 500ms Deadline

Figures 34 and 35 show the results of on-time delivery with six high priority nodes. Again, there is a significant increase of on-time delivery for high priority packets in the 250ms deadline configuration shown in Figure 34. At the 500ms deadline and six high priority nodes of Figure 35, the improvement is diminishing. As the deadline is increased, the amount of traffic in the system also increases. This added traffic contending for the channel from both the added priority nodes and the increase in deadline reduces the performance improvements seen at lower deadlines with fewer priority nodes

The ETE delay improvements noted in Section 4.3.1 enable the improvements in high priority on-time delivery rates. The MAC layer modifications have a combined effect resulting in higher delivery rates. The deadline choices are only increasing the delivery

rates of lower priority traffic and only have a slight effect on high priority traffic. While there is no significant difference between MAC 1 and MAC 2, MAC 1 is resulting in statistically higher on-time delivery rates in the 250 ms configurations with an offered load of 2.00.

#### 4.3.2.1 ANOVA

Figure 36 presents the data used to validate the ANOVA. The first two levels (0.1 and 0.5) of offered load are removed since those data points result in a consistent 100 percent on-time delivery rate. This consistent value with almost no variation is an uninteresting point of the system and is therefore removed.

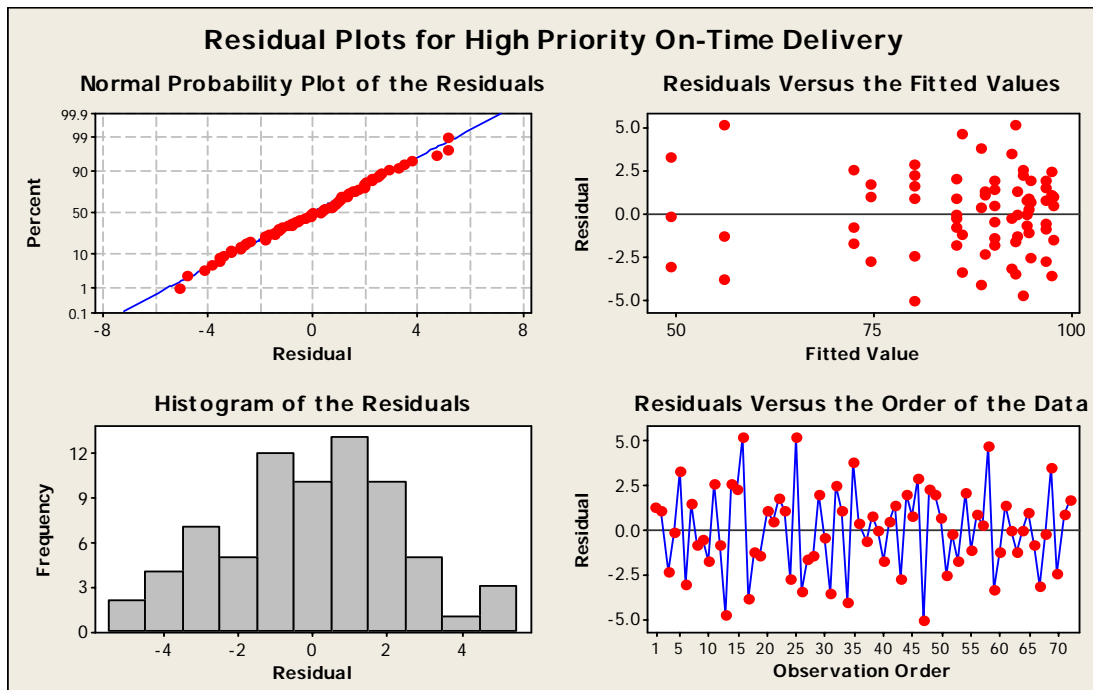

Figure 36. On-Time Delivery ANOVA Validation

The assumptions necessary for the ANOVA are met as shown in Figure 36. Once these assumptions are met, the remaining output from the ANOVA can be used to draw conclusions from experiment data.

#### 4.3.2.2 Factor Interactions

With the validation of assumptions met, the remaining data can be used to draw conclusions on which factor or factor combination has the most impact on performance improvements. The ANOVA table for on-time delivery is listed in Table 2. The complete ANOVA table is found in Table 7 in Appendix B. Table 2 presents the contributions each factor and factor combination has on the performance improvements noted so far.

Table 2. On-Time Delivery ANOVA

Source	DF	Seq SS	Adj SS	Adj MS	F	P
MAC	2	2151.74	2151.74	1075.87	67.46	0.000
OL	1	4765.93	4765.93	4765.93	298.85	0.000
WL	1	1.17	1.17	1.17	0.07	0.788
Deadline	1	232.47	232.47	232.47	14.58	0.000
MAC*OL	2	2042.74	2042.74	1021.37	64.05	0.000
MAC*WL	2	138.66	138.66	69.33	4.35	0.017
MAC*Deadline	2	854.82	854.82	427.41	26.80	0.000
WL*Deadline	1	77.46	77.46	77.46	4.86	0.031
Error	59	940.9	940.90	15.95		
Total	71	11205.89				
S=3.99343	R-Sq=91.60%	R-Sq(adj)=89.90%				

From the Seq SS column, Mac and OL are indicated as the two factors that most contributed to on-time delivery improvements. Deadline also has a slight impact on this improvement as well as several factor combinations. As mentioned previously, OL is not

considered a contributing factor due to its requirement in the system. This leaves Mac as the main contributing factor and deadline with a slight impact.

To illustrate the effects of each factor a main effects plot is shown in Figure 37. This graph identifies the factors with the most impact. It also identifies which level of that factor contributed the most to performance improvements.

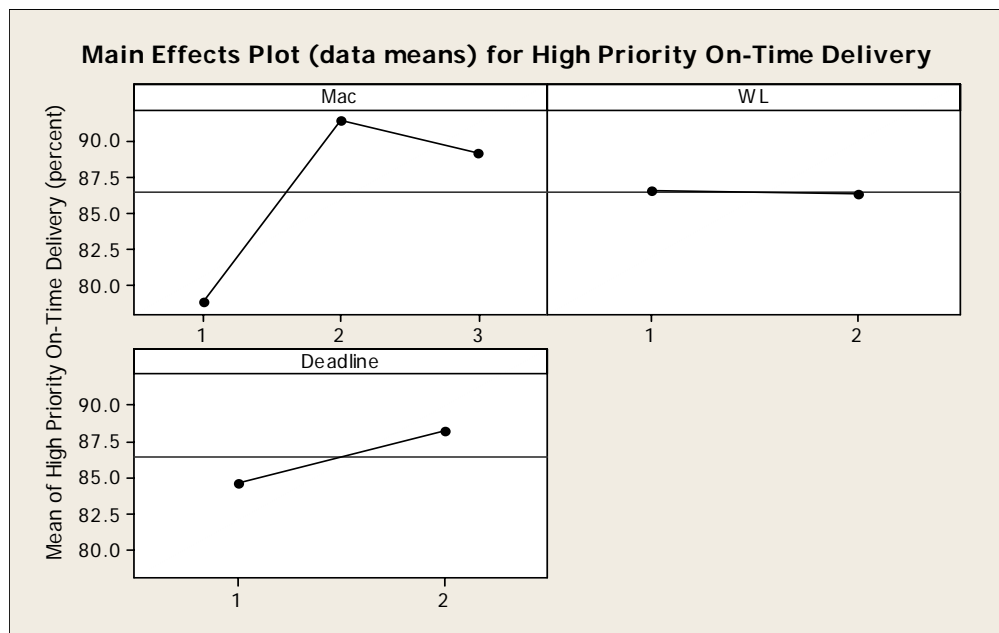

Figure 37. On-Time Delivery Main Effects

From Figure 37 it is readily apparent that the Mac factor indeed contributes the most to the improvements in on-time delivery of high priority messages. Specifically, level 2 (MAC 1) is the most significant with level 3 (MAC 2) contributing slightly less.

Deadline also has an effect on improvement however the impact is relatively small scale when compared to the Mac factor levels. Deadline affects performance since messages are allowed to live longer in the system. This has the effect of increasing the on-time

delivery rates. WL shows almost no difference in the two levels, which agrees with the small value, assigned to it in Table 2 as well as its large p-value.

#### **4.3.2.3 Summary**

Based on the experiment data, ANOVA analysis, confidence intervals, and factor interactions, a significant improvement in on-time delivery of high priority messages occurs at higher loading levels. While these improvements were only evident at high loading levels, systems with very short deadlines would likely have these improvements at every loading level. The ability of the system to provide such high delivery rates even under such unstable network conditions is noteworthy. Both MAC modifications are performing relatively similar based on the confidence intervals. While MAC 1 performs slightly better in the 250 ms deadline, 2.00 offered load, both MAC modifications are contributing to performance improvements.

#### **4.3.3 Throughput**

The final remaining performance metric considered is throughput. The results show no noticeable impact on throughput. Figures 38-41 show the results of the experiments on throughput. While increasing throughput was not a goal of this research, it is important that the modified MAC did not affect throughput. The confidence intervals for throughput are listed in Table 8 in Appendix C. The fact that nearly all confidence intervals overlap supports the experimental data indicating the MAC modifications have no affect on throughput.

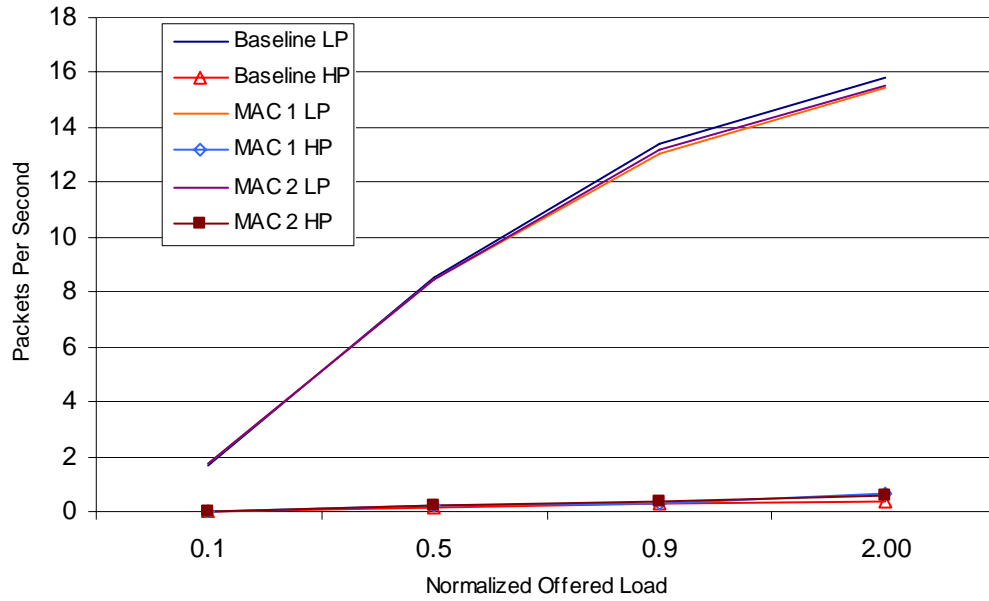

Figure 38. Throughput using 2 High Priority Nodes and 250ms Deadline

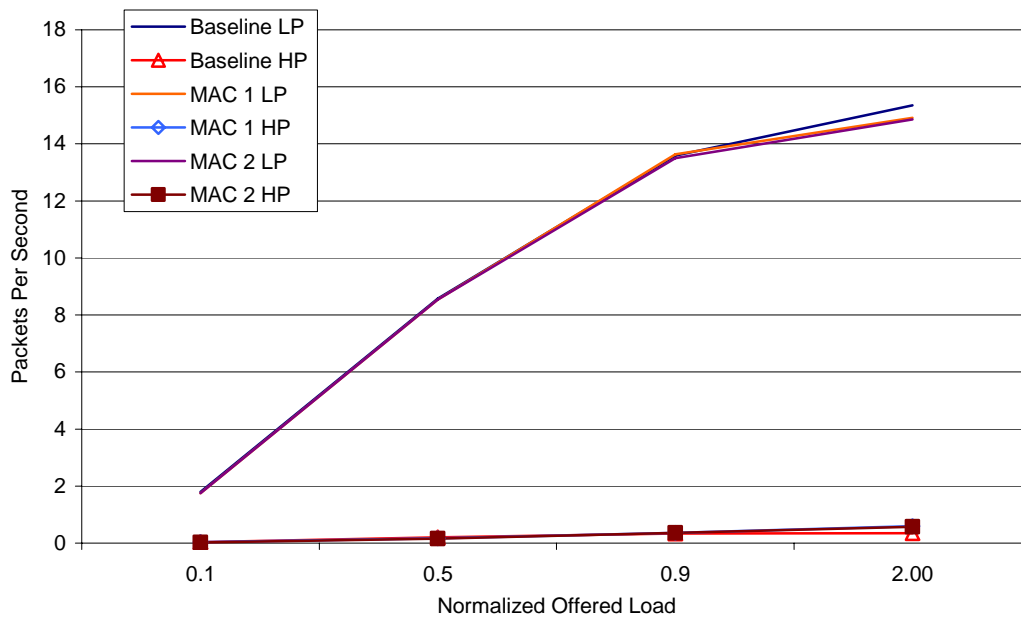

Figure 39. Throughput using 2 High Priority Nodes and 500ms Deadline

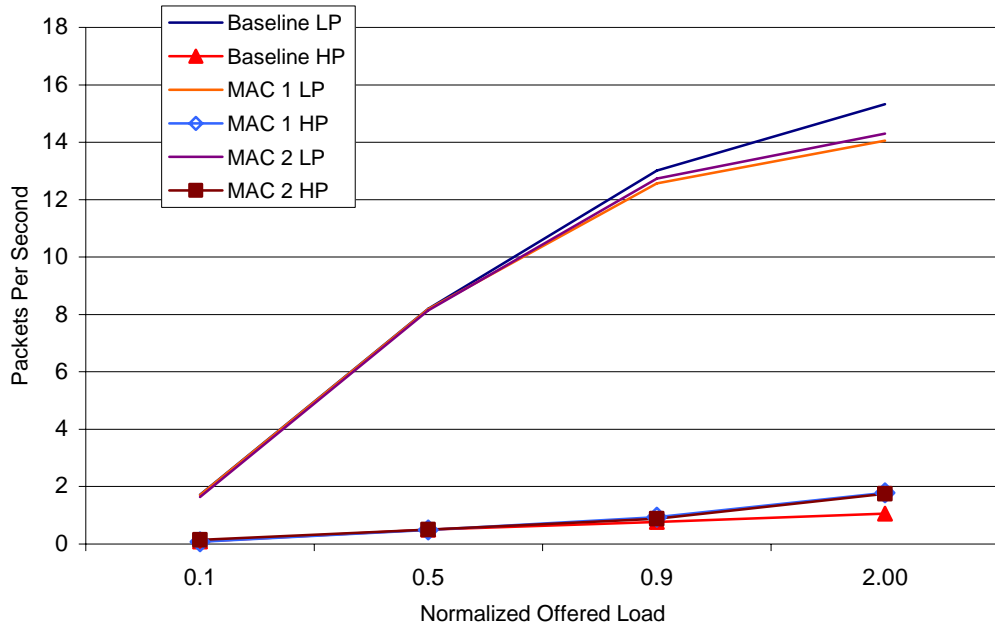

Figure 40. Throughput using 6 High Priority Nodes and 250ms Deadline

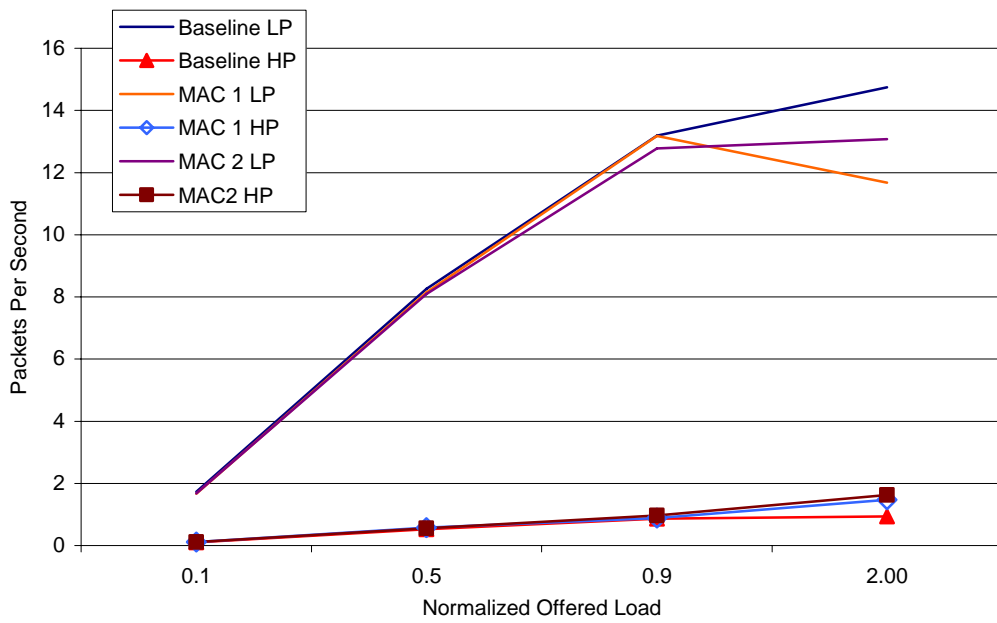

Figure 41 Throughput using 6 High Priority Nodes and 500ms Deadline



These graphs provide visual evidence the modifications to the MAC layer do not affect system throughput. While other research provides real-time performance improvements through an increase of throughput, they did not necessarily provide any priority to critical message delivery. This research, on the other hand, provides priority to critical messages without affecting throughput.

### 4.3.3.1 ANOVA

As accomplished previously, the underlying assumptions are verified through the graphs in Figure 42.

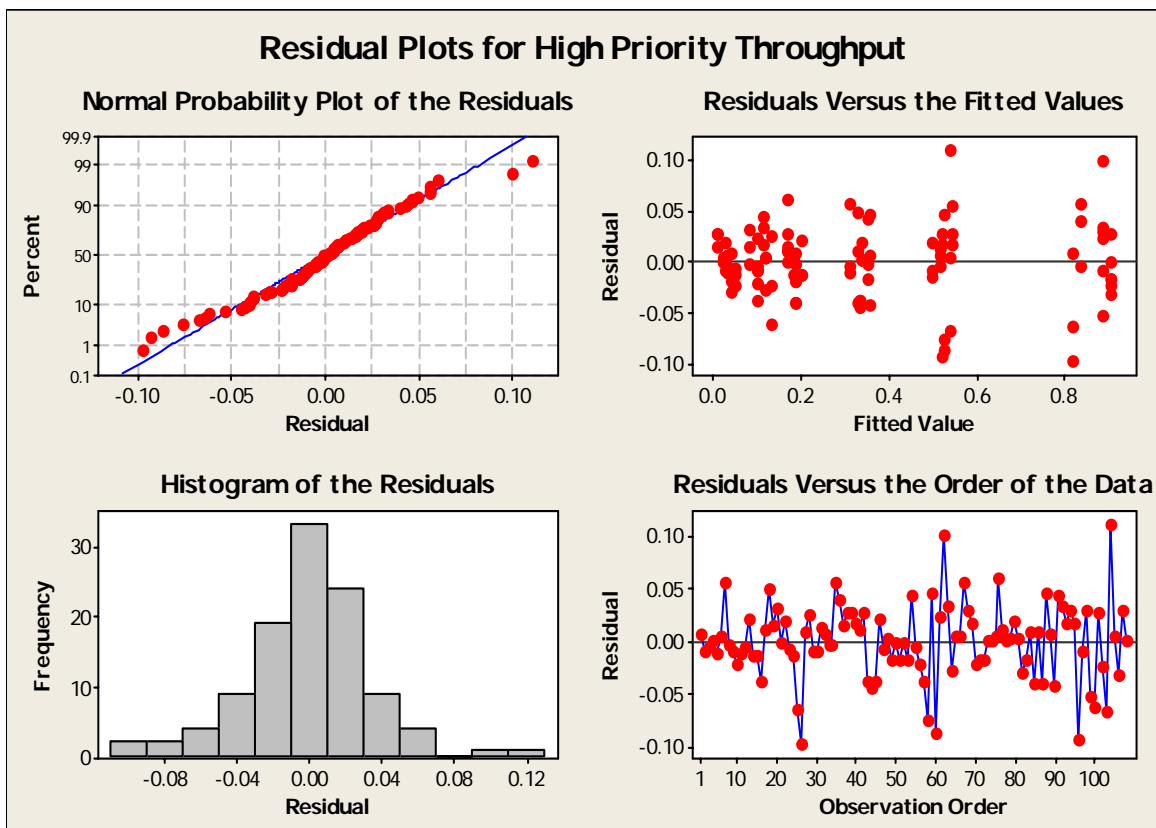

Figure 42. Throughput ANOVA Validation

### 4.3.3.2 Factor Interactions

Table 3 is the ANOVA for throughput. The complete ANOVA is shown in Table 9 in Appendix C. Since it was noted that the modifications were having no impact on throughput, Table 3 shows that the experimental factors have no impact on the results.

Table 3. Throughput ANOVA

Source	DF	Seq SS	Adj SS	Adj MS	F	P
MAC	2	0.00825	0.00825	0.00412	2.83	0.064
OL	2	5.19790	5.19790	2.59895	1786.06	0.000
WL	1	2.74634	2.74634	2.74634	1887.35	0.000
Deadline	1	0.00865	0.00865	0.00865	5.95	0.017
MAC*WL	2	0.01129	0.01129	0.00564	3.88	0.024
OL*WL	2	0.96911	0.96911	0.48455	333.00	0.000
Error	97	0.14115	0.14115	0.00146		
Total	107	9.08268				
S=0.0381462	R-Sq=98.45%	R-Sq (adj)=98.29%				

The Seq SS column of Table 3 indicates that out of the four factors, only OL and WL affected throughput significantly. It is interesting to note that both of these factors adjust the amount of traffic in the system.

As previously done, OL is removed from consideration. This leaves only WL as affecting throughput. This effect is solely due to WL, which increases the amount of traffic in the system by increasing the number of high priority nodes similar to the way that OL increases traffic. Figure 43 graphically presents the main factors and their impact on throughput.

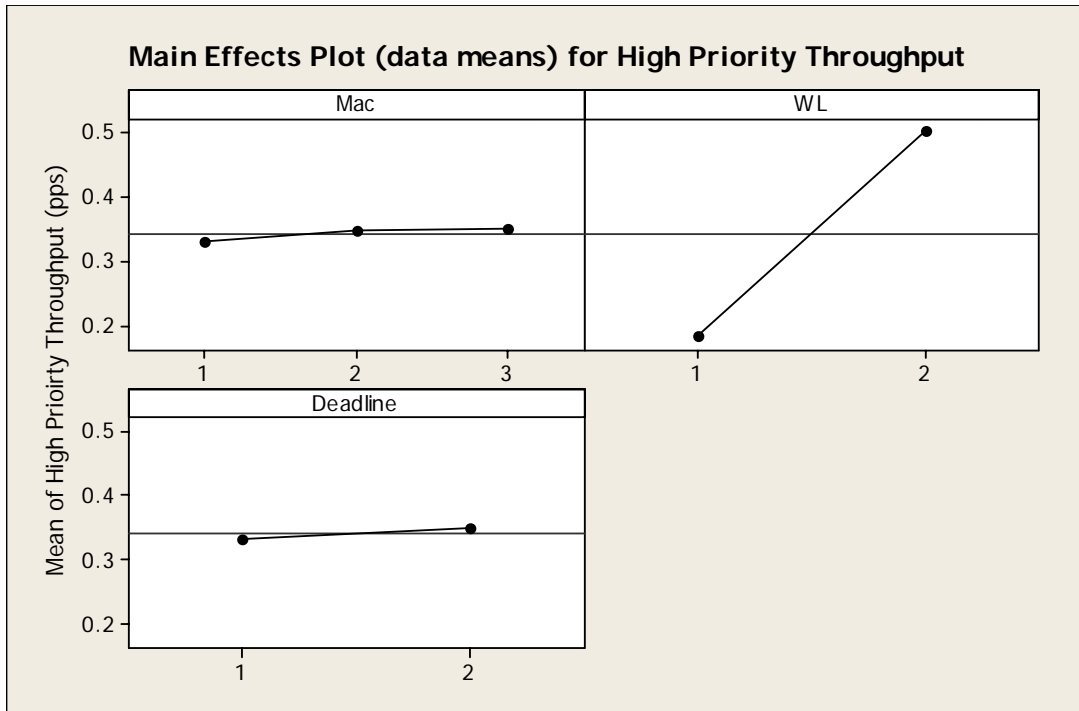

Figure 43. Throughput Main Effects

As indicated in Table 3, the only remaining factor significantly affecting throughput is WL. There is barely any distinguishable impact in any level of the MAC and deadline factors. Since WL serves as a means to increase the high priority load, it is not considered as factor in performance improvements.

#### 4.3.3.3 Summary

By using ANOVA, confidence intervals, and effects plots, the experiment data shows the research modifications have no impact on throughput of either high priority or low priority messages. MAC modifications have improved in ETE delay and on-time delivery, and done so without reducing system throughput. Thus, high priority messages receive priority service while low priority messages do not suffer as a result.

#### 4.4 Summary

The results of the research show a significant improvement in ETE delay for high priority messages and higher on-time delivery rates for high priority messages. There is also no impact to throughput in the system due to these modifications. These results are confirmed and supported using ANOVA tables, and confidence intervals.

Out of the four primary factors, MAC, OL, WL, and Deadline, MAC is the main contributing factor in performance improvements. Both modified MAC levels have a significant impact on performance improvements. While MAC 1 appears to have a slightly larger impact, the confidence intervals of the two levels overlap in too many instances to support a distinction between the two modifications. The performance improvements seen in this chapter are a direct result of choosing smaller backoff values. These smaller backoff values allow priority messages to be sent in a shorter timeframe than other messages resulting in the performance improvements shown in this chapter.

## 5. Conclusions

### 5.1 Introduction

Wireless sensors are becoming an oft-used platform for applications such as battlefield assessment, emergency response, environment monitoring, and intelligence gathering. In these networks, certain messages have a real-time component. The goal of this research was to improve the real-time performance of wireless sensor networks. Three performance metrics were measured to determine what improvements, if any, were made. This chapter provides the conclusions of this research.

### 5.2 Conclusions

The modification of the MAC layer to provide faster processing of high priority messages resulted in lower ETE delays and an increase in on-time delivery rates for high priority messages. These improvements were accomplished without any impact to throughput for either low or high priority messages. These improvements were also accomplished without the synchronization and reservation overhead required by many other protocols.

The additional 1-byte overhead, used to indicate the messages priority level, enabled the MAC layer to make decisions on which messages to transmit first. By modifying the MAC layer to use a smaller range of backoff values when sending high priority messages, they are sent more quickly compared to low priority messages. With these lower ETE delays and higher on-time delivery rates, critical decisions about this information can be made in a significantly shorter timeframe.

### 5.3 Future Research

With the likelihood that more applications will begin to use wireless sensors as a platform of choice, future efforts relating to these nodes can be beneficial. The results of this research were for an isolated bus type architecture. Further work can be conducted in this area analyzing the effects these modifications would have in a larger, routable system. Increasing the number of nodes and hops necessary to reach a destination would show what effect these types of modifications would have on both high and low priority traffic in a large scale system.

## Appendix A. ETE Experiment Data Analysis Tables

Table 4. ETE 90% Confidence Intervals

2 High Priority Generating Nodes 250ms Deadline						6 High Priority Generating Nodes 250ms Deadline					
10% offered load	Mean	StDev	Lower CI	Upper CI	% Improvement	10% offered load	Mean	StDev	Lower CI	Upper CI	% Improvement
Baseline	47.54	5.50	42.32	52.77		Baseline	45.61	8.32	37.70	53.51	
Mac 1	26.47	7.86	19.01	33.93	44.32	Mac 1	25.59	1.88	23.80	27.38	43.89
Mac 2	28.40	4.26	24.36	32.44	40.26	Mac 2	27.41	0.96	26.50	28.33	39.89

500ms Deadline						500ms Deadline					
10% offered load	Mean	StDev	Lower CI	Upper CI	% Improvement	10% offered load	Mean	StDev	Lower CI	Upper CI	% Improvement
Baseline	44.48	13.63	31.54	57.43		Baseline	47.52	7.01	40.86	54.18	
Mac 1	22.13	0.81	21.37	22.90	50.24	Mac 1	24.36	2.09	22.38	26.35	48.73
Mac 2	35.60	8.80	27.24	43.96	19.96	Mac 2	26.31	1.10	25.26	27.35	44.64

250ms Deadline						250ms Deadline					
50% offered load	Mean	StDev	Lower CI	Upper CI	% Improvement	50% offered load	Mean	StDev	Lower CI	Upper CI	% Improvement
Baseline	70.86	7.71	63.54	78.17		Baseline	68.14	3.34	64.96	71.31	
Mac 1	36.45	11.62	25.42	47.48	48.56	Mac 1	40.41	4.85	35.80	45.01	40.70
Mac 2	34.66	1.53	33.21	36.11	51.08	Mac 2	47.52	8.46	39.49	55.55	30.26

500ms Deadline						500ms Deadline					
50% offered load	Mean	StDev	Lower CI	Upper CI	% Improvement	50% offered load	Mean	StDev	Lower CI	Upper CI	% Improvement
Baseline	69.24	4.16	65.29	73.19		Baseline	72.75	1.91	70.94	74.57	
Mac 1	33.65	6.46	27.52	39.79	51.40	Mac 1	45.63	10.14	36.01	55.26	37.27
Mac 2	45.34	5.45	40.16	50.52	34.52	Mac 2	46.05	7.60	38.83	53.26	36.71

250ms Deadline						250ms Deadline					
90% offered load	Mean	StDev	Lower CI	Upper CI	% Improvement	90% offered load	Mean	StDev	Lower CI	Upper CI	% Improvement
Baseline	103.26	7.42	96.21	110.31		Baseline	100.31	2.29	98.14	102.49	
Mac 1	63.18	3.61	59.75	66.61	38.82	Mac 1	61.51	5.89	55.92	67.10	38.68
Mac 2	70.87	16.36	55.34	86.40	31.37	Mac 2	73.42	3.76	69.86	76.99	26.81

500ms Deadline						500ms Deadline					
90% offered load	Mean	StDev	Lower CI	Upper CI	% Improvement	90% offered load	Mean	StDev	Lower CI	Upper CI	% Improvement
Baseline	135.76	8.94	127.27	144.24		Baseline	131.57	5.61	126.24	136.89	
Mac 1	97.60	2.70	95.04	100.16	28.11	Mac 1	110.13	16.57	94.39	125.86	16.30
Mac 2	99.28	11.59	88.28	110.29	26.87	Mac 2	117.21	12.39	105.45	128.98	10.91

250ms Deadline						250ms Deadline					
200% offered load	Mean	StDev	Lower CI	Upper CI	% Improvement	200% offered load	Mean	StDev	Lower CI	Upper CI	% Improvement
Baseline	118.40	10.18	108.73	128.07		Baseline	128.07	6.43	121.96	134.17	
Mac 1	106.21	4.03	102.38	110.04	10.30	Mac 1	100.48	2.43	98.17	102.79	21.54
Mac 2	106.16	4.81	101.60	110.73	10.34	Mac 2	114.40	3.68	110.91	117.89	10.67

500ms Deadline						500ms Deadline					
200% offered load	Mean	StDev	Lower CI	Upper CI	% Improvement	200% offered load	Mean	StDev	Lower CI	Upper CI	% Improvement
Baseline	228.26	36.02	194.06	262.47		Baseline	210.62	10.98	200.20	221.04	
Mac 1	168.89	11.55	157.92	179.85	26.01	Mac 1	155.56	14.02	142.25	168.87	26.14
Mac 2	179.80	22.56	158.38	201.23	21.23	Mac 2	176.37	9.89	166.98	185.76	16.26

Table 5. ETE Delay ANOVA

Source	DF	Seq SS	Adj SS	Adj MS	F	P	
Mac		2	17686.6	17686.6	8843.3	153.06	0.000
OL		2	75572.8	75572.8	37786.4	654.01	0.000
WL		1	115.1	115.1	115.1	1.99	0.162
Deadline		1	4163.2	4163.2	4163.2	72.06	0.000
Mac*OL		4	735.0	735.0	183.7	3.18	0.018
Mac*WL		2	140.6	140.6	70.3	1.22	0.302
Mac*Deadline		2	30.2	30.2	15.1	0.26	0.771
OL*WL		2	183.7	183.7	91.8	1.59	0.211
OL*Deadline		2	6860.7	6860.7	3430.4	59.37	0.000
WL*Deadline		1	35.8	35.8	35.8	0.62	0.434
Mac*OL*WL		4	188.1	188.1	47.0	0.81	0.520
Mac*OL*Deadline		4	239.8	239.8	59.9	1.04	0.394
Mac*WL*Deadline		2	202.7	202.7	101.4	1.75	0.180
OL*WL*Deadline		2	54.0	54.0	27.0	0.47	0.629
Mac*OL*WL*Deadline		4	151.4	151.4	37.9	0.66	0.625
Error		72	4159.9	4159.9	57.8		
Total		107	110519.5				

S=7.60108

R-Sq=96.24% R-Sq(adj)=94.41%



## Appendix B. On-Time Delivery Experiment Data Analysis Tables

Table 6. On-Time Delivery 90% Confidence Intervals

250ms Deadline						250ms Deadline					
90% offered load	Mean	StDev	Lower CI	Upper CI	% Improvement	90% offered load	Mean	StDev	Lower CI	Upper CI	% Improvement
Baseline	89.25	2.05	87.30	91.20		Baseline	94.07	4.18	90.10	98.04	
Mac 1	93.02	4.60	88.66	97.39	4.06	Mac 1	94.38	0.70	93.72	95.04	0.33
Mac 2	94.90	2.35	92.67	97.13	5.96	Mac 2	93.23	1.31	91.99	94.47	-0.90

500ms Deadline						500ms Deadline					
90% offered load	Mean	StDev	Lower CI	Upper CI	% Improvement	90% offered load	Mean	StDev	Lower CI	Upper CI	% Improvement
Baseline	96.80	1.31	95.55	98.05		Baseline	97.81	1.32	96.55	99.06	
Mac 1	97.52	3.18	94.50	100.53	0.74	Mac 1	96.79	2.45	94.46	99.12	-1.05
Mac 2	97.14	1.11	96.09	98.19	0.35	Mac 2	96.35	0.63	95.75	96.95	-1.51

250ms Deadline						250ms Deadline					
200% offered load	Mean	StDev	Lower CI	Upper CI	% Improvement	200% offered load	Mean	StDev	Lower CI	Upper CI	% Improvement
Baseline	49.33	3.19	46.30	52.36		Baseline	55.96	4.66	51.54	60.38	
Mac 1	90.35	1.76	88.67	92.02	45.40	Mac 1	90.23	1.64	88.68	91.79	37.98
Mac 2	85.54	1.95	83.69	87.39	42.33	Mac 2	85.44	0.87	84.61	86.27	34.50

500ms Deadline						500ms Deadline					
200% offered load	Mean	StDev	Lower CI	Upper CI	% Improvement	200% offered load	Mean	StDev	Lower CI	Upper CI	% Improvement
Baseline	72.59	2.31	70.40	74.79		Baseline	74.77	2.44	72.45	77.08	
Mac 1	88.55	3.99	84.76	92.34	18.02	Mac 1	80.31	3.21	77.10	83.52	6.90
Mac 2	86.29	4.21	82.30	90.29	15.88	Mac 2	80.27	2.21	78.17	82.37	6.85

Table 7. On-time Delivery ANOVA

Source	DF	Seq SS	Adj SS	Adj MS	F	P
Mac	2	2151.74	2151.74	1075.87	133.16	0.000
OL	1	4765.93	4765.93	4765.93	589.89	0.000
WL	1	1.17	1.17	1.17	0.14	0.705
Deadline	1	232.47	232.47	232.47	28.77	0.000
Mac*OL	2	2042.74	2042.74	1021.37	126.42	0.000
Mac*WL	2	138.66	138.66	69.33	8.58	0.001
Mac*Deadline	2	854.82	854.82	427.41	52.90	0.000
OL*WL	1	8.62	8.62	8.62	1.07	0.307
OL*Deadline	1	9.54	9.54	9.54	1.18	0.283
WL*Deadline	1	77.46	77.46	77.46	9.59	0.003
Mac*OL*WL	2	27.00	27.00	13.50	1.67	0.199
Mac*OL*Deadline	2	480.27	480.27	240.14	29.72	0.000
Mac*WL*Deadline	2	2.71	2.71	1.36	0.17	0.846
OL*WL*Deadline	1	18.36	18.36	18.36	2.27	0.138
Mac*OL*WL*Deadline	2	6.58	6.58	3.29	0.41	0.668
Error	48	387.81	387.81	8.08		
Total	71	11205.89				

S=2.84243

R-Sq=96.54% R-Sq(adj)=94.88%

## Appendix C. Throughput Experiment Data Analysis Tables

Table 8. Throughput 90% Confidence Intervals							Table 9. Throughput 90% Confidence Intervals						
2 High Priority Generating Nodes							6 High Priority Generating Nodes						
250ms Deadline							250ms Deadline						
10% offered load	Mean	StDev	Lower CI	Upper CI	% Improvement		10% offered load	Mean	StDev	Lower CI	Upper CI	% Improvement	
Baseline	0.03	0.01	0.02	0.04			Baseline	0.09	0.02	0.08	0.11		
Mac 1	0.03	0.01	0.02	0.04	0.00		Mac 1	0.08	0.02	0.06	0.09	-21.43	
Mac 2	0.02	0.00	0.02	0.03	-23.08		Mac 2	0.14	0.01	0.13	0.16	33.77	
500ms Deadline							500ms Deadline						
10% offered load	Mean	StDev	Lower CI	Upper CI	% Improvement		10% offered load	Mean	StDev	Lower CI	Upper CI	% Improvement	
Baseline	0.04	0.01	0.03	0.05			Baseline	0.10	0.02	0.08	0.12		
Mac 1	0.03	0.01	0.02	0.04	-25.00		Mac 1	0.11	0.02	0.09	0.13	10.00	
Mac 2	0.03	0.02	0.01	0.05	-33.33		Mac 2	0.11	0.04	0.07	0.15	8.47	
250ms Deadline							250ms Deadline						
50% offered load	Mean	StDev	Lower CI	Upper CI	% Improvement		50% offered load	Mean	StDev	Lower CI	Upper CI	% Improvement	
Baseline	0.18	0.01	0.17	0.19			Baseline	0.50	0.02	0.48	0.51		
Mac 1	0.19	0.01	0.18	0.19	2.00		Mac 1	0.49	0.07	0.42	0.56	-1.90	
Mac 2	0.19	0.03	0.16	0.22	4.85		Mac 2	0.51	0.07	0.44	0.57	1.83	
500ms Deadline							500ms Deadline						
50% offered load	Mean	StDev	Lower CI	Upper CI	% Improvement		50% offered load	Mean	StDev	Lower CI	Upper CI	% Improvement	
Baseline	0.20	0.02	0.18	0.22			Baseline	0.52	0.01	0.51	0.53		
Mac 1	0.17	0.01	0.16	0.18	-16.13		Mac 1	0.58	0.02	0.56	0.60	9.94	
Mac 2	0.16	0.03	0.13	0.19	-24.14		Mac 2	0.56	0.09	0.47	0.64	6.33	
250ms Deadline							250ms Deadline						
90% offered load	Mean	StDev	Lower CI	Upper CI	% Improvement		90% offered load	Mean	StDev	Lower CI	Upper CI	% Improvement	
Baseline	0.32	0.04	0.29	0.36			Baseline	0.77	0.05	0.72	0.82		
Mac 1	0.29	0.00	0.29	0.30	-10.76		Mac 1	0.94	0.04	0.90	0.98	18.31	
Mac 2	0.34	0.01	0.34	0.35	5.91		Mac 2	0.88	0.04	0.84	0.92	12.26	
500ms Deadline							500ms Deadline						
90% offered load	Mean	StDev	Lower CI	Upper CI	% Improvement		90% offered load	Mean	StDev	Lower CI	Upper CI	% Improvement	
Baseline	0.34	0.04	0.29	0.38			Baseline	0.87	0.03	0.84	0.90		
Mac 1	0.36	0.03	0.33	0.39	6.70		Mac 1	0.89	0.00	0.88	0.89	2.09	
Mac 2	0.36	0.04	0.32	0.40	6.22		Mac 2	0.97	0.09	0.89	1.06	10.50	

250ms Deadline

200% offered load	Mean	StDev	Lower CI	Upper CI	% Improvement
Baseline	0.36	0.04	0.32	0.40	
Mac 1	0.64	0.04	0.60	0.68	43.93
Mac 2	0.59	0.04	0.55	0.63	38.99

250ms Deadline

200% offered load	Mean	StDev	Lower CI	Upper CI	% Improvement
Baseline	1.06	0.04	1.02	1.10	
Mac 1	1.78	0.09	1.69	1.87	40.54
Mac 2	1.75	0.09	1.66	1.84	39.47

500ms Deadline

200% offered load	Mean	StDev	Lower CI	Upper CI	% Improvement
Baseline	0.34	0.04	0.31	0.38	
Mac 1	0.59	0.06	0.53	0.65	42.19
Mac 2	0.57	0.07	0.51	0.63	39.94

500ms Deadline

200% offered load	Mean	StDev	Lower CI	Upper CI	% Improvement
Baseline	0.94	0.08	0.86	1.02	
Mac 1	1.47	0.07	1.40	1.54	36.15
Mac 2	1.62	0.04	1.58	1.66	42.12

Table 9. Throughput ANOVA

Source	DF	Seq SS	Adj SS	Adj MS	F	P
Mac	2	0.00825	0.00825	0.00412	3.67	0.03
OL	2	5.1979	5.1979	2.59895	2315.83	0
WL	1	2.74634	2.74634	2.74634	2447.16	0
Deadline	1	0.00865	0.00865	0.00865	7.71	0.007
Mac*OL	4	0.01022	0.01022	0.00255	2.28	0.069
Mac*WL	2	0.01129	0.01129	0.00564	5.03	0.009
Mac*Deadline	2	0.00239	0.00239	0.00119	1.06	0.35
OL*WL	2	0.96911	0.96911	0.48455	431.77	0
OL*Deadline	2	0.00316	0.00316	0.00158	1.41	0.251
WL*Deadline	1	0.00231	0.00231	0.00231	2.06	0.155
Mac*OL*WL	4	0.00866	0.00866	0.00216	1.93	0.115
Mac*OL*Deadline	4	0.00426	0.00426	0.00106	0.95	0.441
Mac*WL*Deadline	2	0.00072	0.00072	0.00036	0.32	0.726
OL*WL*Deadline	2	0.00668	0.00668	0.00334	2.98	0.057
Mac*OL*WL*Deadline	4	0.02195	0.02195	0.00549	4.89	0.002
Error	72	0.0808	0.0808	0.00112		
Total	107	9.08268				

S=0,0335001

R-Sq=99.11% R-Sq(adj)=98.68%

## Bibliography

- [Bal99] Baldwin, Rusty O. Improving The Real-Time Performance of a Wireless Local Area Network. Ph.D. dissertation. Virginia Polytechnical Institute, Blacksburg VA, 1999.
- [CCG00] Cali, Federico, Marco Conti, and Enrico Gregori. "IEEE 802.11 Protocol: Design and Performance of an Adaptive Backoff Mechanism," IEEE Journal on Selected Areas in Communications 18: 1774-1786 (September 2000).
- [CGL00] Chandra, Ajay, V. Gummalla, and John O. Limb. "Wireless Collision Detect (WCD): Multiple Access with Receiver Initiated Feedback and Carrier Detect Signal," IEEE International Conference on Communications, 1: 397-401 (June 2000).
- [FAM03] Fitzek Frank H., Diego Angelini, Gianluca Mazzini, and Michele Zorzi. "Design and Performance of an Enhanced IEEE 802.11 MAC Protocol for Multihop Coverage Extension," IEEE Wireless Communications, 10: 30-39 (December 2003).
- [FoF06] Fonda, Carlo, and Fulvio Postogna. "Computer Networking Basics." Image from unpublished article. n. pag. [http://www.ictp.trieste.it/~radionet/1998\\_school/networking\\_presentation/index.html](http://www.ictp.trieste.it/~radionet/1998_school/networking_presentation/index.html). 13 January 2006.
- [JLW04] Sheu, Jang-Ping, Chi-Hsun Liu, Shih-Lin Wu, and Yu-Chee Tseng. "A Priority MAC Protocol to Support Real-Time Traffic in Ad Hoc Networks," Wireless Networks, 10: 61-69 (January 2004).
- [JMM03] Jagadeesan, S., B. S. Manoj, and C. Siva Ram Murthy. "Interleaved Carrier Sense Multiple Access: An Efficient MAC Protocol for Ad hoc Wireless Networks," IEEE International Conference on Communications, 2: 1124-1128 (2003).
- [JRK03] Ju, Huei-Jiun Izhak Rubin, and Yen-Cheng Kuan. "An Adaptive RTS/CTS Control Mechanism for IEEE 802.11 MAC Protocol," IEEE Vehicular Technology Conference, 57: 1469-1473 (2003).
- [KFL03] Kwon, Younggoo, Yuguang Fang, and Haniph Latchman. "A Novel MAC Protocol with Fast Collision Resolution for Wireless LANs," IEEE INFOCOM Proceedings 2: 853-862 (2003).
- [LLF01] Liu, Kai, Jinandong Li, and Akira Fukuda. "Adaptive Acquisition Collision Avoidance Multiple Access for Multihop Ad Hoc Wireless Networks," Global Telecommunications Conference, 5: 2880-2884 (November 2001).
- [Mul06] "Multiple Division Techniques." Image from unpublished article. n. pag. <http://www.cs.purdue.edu/homes/bb/cs690b/Chapt-07.ppt#285,3>, Frequency Division Multiple Access (FDMA). 13 January 2006.

- [Rap96] Rappaport, Theodore S. Wireless Communications. New Jersey: Prentice Hall, 1996.
- [RKK04] Raguin, David, Martin Kubisch, Holger Karl, and Adam Wolisz. "Queue-driven Cut-through Medium Access in Wireless Ad Hoc Networks," IEEE Wireless Communications and Networking Conference, 3: 1909-1914 (2004).
- [RPS01] Rezvan, M., K. Pawlikowski, and H. Sirisena. "An adaptive reservation scheme for VBR voice traffic in wireless ATM networks," Telecommunications Systems, 1-2: 103-113 (2001).
- [SaL01] Santamaria, Asuncion and Francisco J. Lopez-Hernandez. Wireless LAN Standards and Applications. Massachusetts: Artech House, 2001.
- [SCC03] Sheu, Shiann-Tsong, Tobias Chen, Jenhui Chen, and Fun Ye. "The Impact of RTS Threshold on IEEE 802.11 MAC Protocol," Tamkang Journal of Science and Engineering, 6: 57-63 (March 2003).
- [Sta92] Stallings, William Computer Communications. California: IEEE Computer Society Press, 1992.
- [Tan96] Tanenbaum, Andrew S. Computer Networks. New Jersey: Prentice Hall, 1996.
- [WaG03] Wang, Yu and J. J. Garcia-Luna-Aceves. "Throughput and Fairness in A Hybrid Channel Access Scheme for Ad Hoc Networks," Wireless Communications and Networking, 2: 988-993 (March 2003).
- [80206] "802.11 MAC (Media Access Control)." Image from unpublished article. n. pag. [http://www.zytrax.com/tech/wireless/802\\_mac.htm](http://www.zytrax.com/tech/wireless/802_mac.htm) 13 January 2006.

<b>REPORT DOCUMENTATION PAGE</b>				<i>Form Approved OMB No. 074-0188</i>	
The public reporting burden for this collection of information is estimated to average 1 hour per response, including the time for reviewing instructions, searching existing data sources, gathering and maintaining the data needed, and completing and reviewing the collection of information. Send comments regarding this burden estimate or any other aspect of the collection of information, including suggestions for reducing this burden to Department of Defense, Washington Headquarters Services, Directorate for Information Operations and Reports (0704-0188), 1215 Jefferson Davis Highway, Suite 1204, Arlington, VA 22202-4302. Respondents should be aware that notwithstanding any other provision of law, no person shall be subject to a penalty for failing to comply with a collection of information if it does not display a currently valid OMB control number. <b>PLEASE DO NOT RETURN YOUR FORM TO THE ABOVE ADDRESS.</b>					
<b>1. REPORT DATE (DD-MM-YYYY)</b> 23-03-2006		<b>2. REPORT TYPE</b> Master's Thesis		<b>3. DATES COVERED (From - To)</b> Aug 2004 - March 2006	
<b>4. TITLE AND SUBTITLE</b>  A Real-time Wireless Sensor Media Access Control (MAC) Protocol				<b>5a. CONTRACT NUMBER</b>	
				<b>5b. GRANT NUMBER</b>	
				<b>5c. PROGRAM ELEMENT NUMBER</b>	
<b>6. AUTHOR(S)</b>  Park, Barry W., TSgt, USAF				<b>5d. PROJECT NUMBER</b>	
				<b>5e. TASK NUMBER</b>	
				<b>5f. WORK UNIT NUMBER</b>	
<b>7. PERFORMING ORGANIZATION NAMES(S) AND ADDRESS(S)</b> Air Force Institute of Technology Graduate School of Engineering and Management (AFIT/EN) 2950 Hobson Way, Building 640 WPAFB OH 45433-8865				<b>8. PERFORMING ORGANIZATION REPORT NUMBER</b>  AFIT/GIA/ENG/06-08	
<b>9. SPONSORING/MONITORING AGENCY NAME(S) AND ADDRESS(ES)</b> Scott Gardner, P.E. Air Force Communication Agency Dynamic Network Analysis Division AFCA/ENAN Scott AFB, IL 62225 DSN 779-6794 Com 618-229-6794				<b>10. SPONSOR/MONITOR'S ACRONYM(S)</b>	
				<b>11. SPONSOR/MONITOR'S REPORT NUMBER(S)</b>	
<b>12. DISTRIBUTION/AVAILABILITY STATEMENT</b>  APPROVED FOR PUBLIC RELEASE; DISTRIBUTION UNLIMITED.					
<b>13. SUPPLEMENTARY NOTES</b>					
<b>14. ABSTRACT</b> Wireless sensor networks are rapidly becoming a platform for applications such as battlefield monitoring, intelligence gathering, environmental monitoring, and emergency response. Inherent in these applications is a priority and urgency of the information or messages. This means the messages must be delivered in a timely manner for them to be useful. This research assigns a message priority level and provides high priority messages quicker access to the channel.  Using MICA2 sensors and a modified Media Access Control (MAC) layer, real-time message End-to-End (ETE) delay was reduced by 50 percent. Coupled with this decrease in delay, these same real-time messages also had a significantly higher on-time delivery rate compared to an unmodified system. At the highest loading levels, high priority messages experienced a 45 percent higher on-time delivery rate than the baseline system. These performance improvements were obtained without any impact on throughput for other message types and without the added overhead of channel reservation or system synchronization required by other protocols.					
<b>15. SUBJECT TERMS</b> Wireless Communications , Sensor Networks, Real-time, Media Access Control (MAC)					
<b>16. SECURITY CLASSIFICATION OF:</b>			<b>17. LIMITATION OF ABSTRACT</b>	<b>18. NUMBER OF PAGES</b>	<b>19a. NAME OF RESPONSIBLE PERSON</b>
<b>a. REPORT</b>	<b>b. ABSTRACT</b>	<b>c. THIS PAGE</b>			<b>19b. TELEPHONE NUMBER (Include area code)</b>
U	U	U	UU	93	Rusty O. Baldwin, PhD (ENG) (937) 255-3636, ext 4612 (Rusty.Baldwin@afit.edu)

Standard Form 298 (Rev. 8-98)  
Prescribed by ANSI Std. Z39-18

